



Programmable Controller

MELSEC **Q** series

# Channel Isolated Digital-Analog Converter Module User's Manual

---

-Q66DA-G  
-GX Configurator-DA (SW2D5C-QDAU-E)

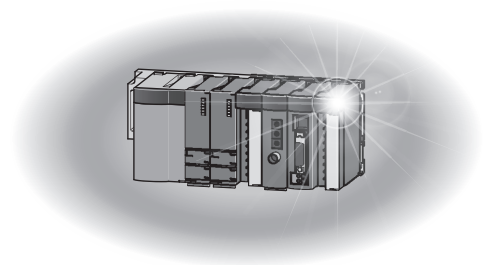



# ● SAFETY PRECAUTIONS ●

(Read these precautions before using this product.)

Before using this product, please read this manual and the relevant manuals carefully and pay full attention to safety to handle the product correctly.

The precautions given in this manual are concerned with this product only. For the safety precautions of the programmable controller system, refer to the user's manual for the CPU module used.

In this manual, the safety precautions are classified into two levels: "⚠ WARNING" and "⚠ CAUTION".



Indicates that incorrect handling may cause hazardous conditions, resulting in death or severe injury.



Indicates that incorrect handling may cause hazardous conditions, resulting in minor or moderate injury or property damage.

Under some circumstances, failure to observe the precautions given under "⚠ CAUTION" may lead to serious consequences.

Observe the precautions of both levels because they are important for personal and system safety. Make sure that the end users read this manual and then keep the manual in a safe place for future reference.

## [Design Precautions]

### ⚠ WARNING

- Do not write any data to the "system area" of the buffer memory in the intelligent function module. Also, do not use any "use prohibited" signals as an output signal from the programmable controller CPU to the intelligent function module. Doing so may cause malfunction of the programmable controller system.

### ⚠ CAUTION

- Do not install the control lines or communication cables together with the main circuit lines or power cables. Keep a distance of 100mm (3.9 inches) or more between them. Failure to do so may result in malfunction due to noise.
- At power-on, a voltage may occur or a current may flow between output terminals for a moment. In this case, start the control after analog outputs become stable.

## [Installation Precautions]

### CAUTION

- Use the programmable controller in an environment that meets the general specifications in the user's manual for the CPU module used.  
Failure to do so may result in electric shock, fire, malfunction, or damage to or deterioration of the product.
- To mount the module, while pressing the module mounting lever located in the lower part of the module, fully insert the module fixing projection(s) into the hole(s) in the base until it snaps into place.  
Incorrect mounting may cause malfunction, failure or drop of the module.  
Fix the module to the base unit with a fixing bracket.
- Tighten the screw within the specified torque range.  
Undertightening can cause drop of the screw, short circuit or malfunction.  
Overtightening can damage the screw and/or module, resulting in drop, short circuit, or malfunction.
- Shut off the external power supply (all phases) used in the system before mounting or removing the module.  
Failure to do so may result in damage to the product.  
A module can be replaced online (while power is on) on any MELSECNET/H remote I/O station or in the system where a CPU module supporting the online module change function is used.  
Note that there are restrictions on the modules that can be replaced online, and each module has its predetermined replacement procedure.  
For details, refer to the relevant chapter in this manual.
- Do not directly touch any conductive parts and electronic components of the module.  
Doing so can cause malfunction or failure of the module.

## [Wiring Precautions]

### CAUTION

- Individually ground the FG terminal of the programmable controller with a ground resistance of  $100\Omega$  or less.  
Failure to do so may result in electric shock or malfunction.
- Tighten the terminal screw within the specified torque range.  
Undertightening can cause short circuit, fire, or malfunction.  
Overtightening can damage the screw and/or module, resulting in drop, short circuit, or malfunction.
- Prevent foreign matter such as dust or wire chips from entering the module.  
Such foreign matter can cause a fire, failure, or malfunction.

## [Wiring Precautions]

### CAUTION

- A protective film is attached to the top of the module to prevent foreign matter, such as wire chips, from entering the module during wiring.  
Do not remove the film during wiring.  
Remove it for heat dissipation before system operation.

## [Startup and Maintenance Precautions]

### WARNING

- Do not touch any terminal while power is on.  
Doing so will cause electric shock or malfunction.
- Shut off the external power supply (all phases) used in the system before cleaning the module or retightening the terminal screws, connector screws, or module fixing screws.  
Failure to do so may result in electric shock or cause the module to fail or malfunction.  
Undertightening can cause drop of the screw, short circuit or malfunction.  
Overtightening can damage the screw and/or module, resulting in drop, short circuit, or malfunction.

## [Startup and Maintenance Precautions]

### CAUTION

- Do not disassemble or modify the modules.  
Doing so may cause failure, malfunction, injury, or a fire.
- Shut off the external power supply (all phases) used in the system before mounting or removing the module.  
Failure to do so may cause the module to fail or malfunction.  
A module can be replaced online (while power is on) on any MELSECNET/H remote I/O station or in the system where a CPU module supporting the online module change function is used.  
Note that there are restrictions on the modules that can be replaced online, and each module has its predetermined replacement procedure.  
For details, refer to the relevant chapter in this manual.
- After the first use of the product, do not mount/remove the module to/from the base unit more than 50 times (IEC 61131-2 compliant).  
Exceeding the limit of 50 times may cause malfunction.
- Before handling the module, touch a grounded metal object to discharge the static electricity from the human body.  
Failure to do so may cause the module to fail or malfunction.

## [Disposal Precautions]

 **CAUTION**

- When disposing of this product, treat it as industrial waste.

# ● CONDITIONS OF USE FOR THE PRODUCT ●

- (1) Mitsubishi programmable controller ("the PRODUCT") shall be used in conditions;
- i) where any problem, fault or failure occurring in the PRODUCT, if any, shall not lead to any major or serious accident; and
  - ii) where the backup and fail-safe function are systematically or automatically provided outside of the PRODUCT for the case of any problem, fault or failure occurring in the PRODUCT.
- (2) The PRODUCT has been designed and manufactured for the purpose of being used in general industries.

MITSUBISHI SHALL HAVE NO RESPONSIBILITY OR LIABILITY (INCLUDING, BUT NOT LIMITED TO ANY AND ALL RESPONSIBILITY OR LIABILITY BASED ON CONTRACT, WARRANTY, TORT, PRODUCT LIABILITY) FOR ANY INJURY OR DEATH TO PERSONS OR LOSS OR DAMAGE TO PROPERTY CAUSED BY the PRODUCT THAT ARE OPERATED OR USED IN APPLICATION NOT INTENDED OR EXCLUDED BY INSTRUCTIONS, PRECAUTIONS, OR WARNING CONTAINED IN MITSUBISHI'S USER, INSTRUCTION AND/OR SAFETY MANUALS, TECHNICAL BULLETINS AND GUIDELINES FOR the PRODUCT.

("Prohibited Application")

Prohibited Applications include, but not limited to, the use of the PRODUCT in;

- Nuclear Power Plants and any other power plants operated by Power companies, and/or any other cases in which the public could be affected if any problem or fault occurs in the PRODUCT.
- Railway companies or Public service purposes, and/or any other cases in which establishment of a special quality assurance system is required by the Purchaser or End User.
- Aircraft or Aerospace, Medical applications, Train equipment, transport equipment such as Elevator and Escalator, Incineration and Fuel devices, Vehicles, Manned transportation, Equipment for Recreation and Amusement, and Safety devices, handling of Nuclear or Hazardous Materials or Chemicals, Mining and Drilling, and/or other applications where there is a significant risk of injury to the public or property.

Notwithstanding the above, restrictions Mitsubishi may in its sole discretion, authorize use of the PRODUCT in one or more of the Prohibited Applications, provided that the usage of the PRODUCT is limited only for the specific applications agreed to by Mitsubishi and provided further that no special quality assurance or fail-safe, redundant or other safety features which exceed the general specifications of the PRODUCTS are required. For details, please contact the Mitsubishi representative in your region.

REVISIONS

\* The manual number is given on the bottom left of the back cover.

Print Date	*Manual Number	Revision
Oct., 2006	SH (NA)-080648ENG-A	First edition
Jan., 2007	SH (NA)-080648ENG-B	Correction Section 3.2.1, 4.6
Jan., 2008	SH (NA)-080648ENG-C	Correction SAFETY PRECAUTIONS, About the Generic Terms and Abbreviations, Section 1.1, 2.1, 2.3, 4.1, 4.6, 5.2.1, 5.2.2, 7.3.3, 7.3.5, 8.1, Appendix 1, 1.1 to 1.3 Addition Section 2.2
May, 2008	SH (NA)-080648ENG-D	Correction SAFETY PRECAUTIONS, Compliance with the EMC and Low Voltage Directives, About the Generic Terms and Abbreviations, Section 2.1, 2.3, 4.1, 4.3, 5.1, 5.2.1, 5.2.2, 5.3.1, 5.3.3, Chapter 7, Section 7.1
Nov., 2010	SH (NA)-080648ENG-E	Correction SAFETY PRECAUTIONS, RELATED MANUALS, ABOUT THE GENERIC TERMS AND ABBREVIATIONS, PRODUCT STRUCTURE, Section 1.1, 2.1 to 2.3, 3.1.1, 3.1.2, 3.2, 3.2.1, 3.2.3, 3.2.5, 3.3.1, 3.3.2, 3.4.1, 3.4.3, 3.4.4, 3.4.6, 4.1, 4.3, 4.4.2, 4.5, 4.6, 5.1, 5.2.1, 5.2.2, 5.3.1, 5.3.3, 5.4, 5.5, 5.6.1, 5.6.2, 5.7, 6.2.3, 6.3, 6.3.1, 6.3.2, 7.1, 7.2, 7.3.1 to 7.3.6, 7.4, 7.5, 8.1, 8.2.4, 8.2.6, 8.2.7, Appendix 1, 1.1 to 1.3 Addition CONDITIONS OF USE FOR THE PRODUCT, Appendix 2
Feb., 2012	SH (NA)-080648ENG-F	Correction SAFETY PRECAUTIONS, COMPLIANCE WITH EMC AND LOW VOLTAGE DIRECTIVES, GENERIC TERMS AND ABBREVIATIONS, Section 3.1.1, 3.1.2, 3.2.2, 4.1, 4.3, 4.4.2, 5.2.2, 5.4, 5.5, 6.2.2, 6.2.3, 6.3, Chapter 7, Section 7.1, 7.3.4
Dec., 2012	SH (NA)-080648ENG-G	Correction MANUALS, COMPLIANCE WITH EMC AND LOW VOLTAGE DIRECTIVES, Section 2.1, 2.2, 3.2.2, 3.2.4, 3.3.2, 3.4.2, 4.2, 4.3, 4.4.2, 4.5, 4.6, 5.2, 5.2.1, 5.2.2, 6.2.1, 8.1, 8.2.1, 8.2.4, 8.2.7, Appendix 1.1 to Appendix 1.3
May., 2015	SH (NA)-080648ENG-H	Correction GENERIC TERMS AND ABBREVIATIONS, Section 2.1, 2.3, 4.3, 4.6, Appendix 3



Print Date	*Manual Number	Revision
Jul., 2017	SH (NA)-080648ENG-I	<div style="border: 1px solid black; padding: 2px;">Correction</div> INTRODUCTION, COMPLIANCE WITH EMC AND LOW VOLTAGE DIRECTIVES, GENERIC TERMS AND ABBREVIATIONS, 4.4.2, 4.5  <div style="border: 1px solid black; padding: 2px;">Addition</div> Section 4.4.3, 8.2.7

Japanese Manual Version SH-080646-K

This manual confers no industrial property rights or any rights of any other kind, nor does it confer any patent licenses. Mitsubishi Electric Corporation cannot be held responsible for any problems involving industrial property rights which may occur as a result of using the contents noted in this manual.

© 2006 MITSUBISHI ELECTRIC CORPORATION

## INTRODUCTION

Thank you for purchasing the Mitsubishi Electric MELSEC-Q series programmable controllers. Before using the equipment, please read this manual carefully to develop full familiarity with the functions and performance of the Q series programmable controller you have purchased, so as to ensure correct use.

Please forward a copy of this manual to the end user.

## CONTENTS

SAFETY PRECAUTIONS .....	A - 1
CONDITIONS OF USE FOR THE PRODUCT .....	A - 5
REVISIONS.....	A - 6
INTRODUCTION.....	A - 8
CONTENTS .....	A - 8
MANUALS.....	A - 12
RELEVANT MANUALS.....	A - 12
COMPLIANCE WITH EMC AND LOW VOLTAGE DIRECTIVES .....	A - 12
GENERIC TERMS AND ABBREVIATIONS.....	A - 13
PACKING LIST .....	A - 13

---

### **1 OVERVIEW** **1 - 1 to 1 - 2**

---

1.1 Features.....	1 - 1
-------------------	-------

---

---

### **2 SYSTEM CONFIGURATION** **2 - 1 to 2 - 6**

---

2.1 Applicable Systems .....	2 - 1
2.2 Precautions on System Configuration .....	2 - 3
2.3 Checking Function Version, Serial Number and Software Version .....	2 - 4

---

---

### **3 SPECIFICATIONS** **3 - 1 to 3 - 36**

---

3.1 Performance Specifications .....	3 - 1
3.1.1 Performance specifications list .....	3 - 1
3.1.2 I/O conversion characteristics .....	3 - 2
3.1.3 Accuracy.....	3 - 7
3.1.4 Conversion speed.....	3 - 7
3.2 Function List .....	3 - 8
3.2.1 Analog output HOLD/CLEAR function .....	3 - 9
3.2.2 Analog output test during programmable controller CPU STOP .....	3 - 11
3.2.3 Warning output function.....	3 - 12
3.2.4 Rate control function.....	3 - 14
3.2.5 Scaling function .....	3 - 16
3.3 I/O Signals for the Programmable Controller CPU .....	3 - 19
3.3.1 List of I/O signals .....	3 - 19
3.3.2 Details of I/O signals.....	3 - 20

3.4	Buffer Memory .....	3 - 25
3.4.1	Buffer memory assignment.....	3 - 25
3.4.2	D/A conversion enable/disable setting (Un\G0).....	3 - 28
3.4.3	CH[]Digital value (Un\G1 to Un\G6).....	3 - 28
3.4.4	CH[]Set value check code (Un\G11 to Un\G16).....	3 - 29
3.4.5	Error code (Un\G19).....	3 - 29
3.4.6	Setting range (Un\G20, Un\G21).....	3 - 30
3.4.7	Offset/gain setting mode Offset/gain specification (Un\G22, Un\G23).....	3 - 31
3.4.8	Offset/gain adjustment value specification (Un\G24).....	3 - 31
3.4.9	Offset/gain range setting (Un\G25).....	3 - 32
3.4.10	Rate control enable/disable setting (Un\G46).....	3 - 32
3.4.11	Warning output setting (Un\G47).....	3 - 32
3.4.12	Warning output flag (Un\G48).....	3 - 33
3.4.13	CH[]Scaling enable/disable setting (Un\G53).....	3 - 33
3.4.14	CH[]Scaling upper/lower limit value (Un\G54 to Un\G65).....	3 - 34
3.4.15	CH[]Increase/decrease digital limit value (Un\G70 to Un\G81).....	3 - 34
3.4.16	CH[]Warning output upper/lower limit value (Un\G86 to Un\G97).....	3 - 34
3.4.17	Mode switching setting (Un\G158, Un\G159).....	3 - 35
3.4.18	Pass data classification setting (Un\G200).....	3 - 35
3.4.19	Industrial shipment settings and user range settings offset/gain values (Un\G202 to Un\G225) .....	3 - 36

---

<b>4 SETUP AND PROCEDURES BEFORE OPERATION</b>	<b>4 - 1 to 4 - 17</b>
--	------------------------

---

4.1	Handling Precautions.....	4 - 1
4.2	Setup and Procedures Before Operation.....	4 - 3
4.3	Part Names.....	4 - 4
4.4	Wiring.....	4 - 6
4.4.1	Wiring precautions.....	4 - 6
4.4.2	External wiring.....	4 - 7
4.4.3	Connector/terminal block converter module.....	4 - 8
4.5	Intelligent Function Module Switch Setting.....	4 - 9
4.6	Offset/Gain Settings.....	4 - 12

---

<b>5 UTILITY PACKAGE (GX Configurator-DA)</b>	<b>5 - 1 to 5 - 34</b>
---	------------------------

---

5.1	Utility Package Functions .....	5 - 1
5.2	Installing and Uninstalling the Utility Package .....	5 - 2
5.2.1	Handling precautions.....	5 - 2
5.2.2	Operating environment.....	5 - 4
5.3	Utility Package Operation .....	5 - 6
5.3.1	Common utility package operations .....	5 - 6
5.3.2	Operation overview.....	5 - 9
5.3.3	Starting the Intelligent function module utility .....	5 - 11
5.4	Initial Setting .....	5 - 15
5.5	Auto Refresh Setting.....	5 - 17
5.6	Monitoring/Test .....	5 - 20
5.6.1	Monitor/test screen .....	5 - 20

5.6.2	Offset/gain setting operation.....	5 - 23
5.6.3	Confirmation of Conversion Characteristic .....	5 - 25
5.6.4	Pass data.....	5 - 27
5.7	FB Conversion of Initial Setting/Auto Refresh Setting .....	5 - 29
5.8	Usage of FB.....	5 - 31
5.8.1	Outline .....	5 - 31
5.8.2	Paste an FB to a Sequence Program.....	5 - 33
5.8.3	Convert (Compile) a Sequence Program.....	5 - 34

---

## 6 PROGRAMMING

**6 - 1 to 6 - 18**

6.1	Programming Procedure.....	6 - 1
6.2	For Use in Normal System Configuration .....	6 - 2
6.2.1	Before creating a program .....	6 - 3
6.2.2	Program example using the utility package .....	6 - 5
6.2.3	Programming example without using the utility package.....	6 - 8
6.3	For Use on Remote I/O Network .....	6 - 10
6.3.1	Program example using the utility package .....	6 - 12
6.3.2	Program example without using the utility package.....	6 - 15

---

## 7 ONLINE MODULE CHANGE

**7 - 1 to 7 - 38**

7.1	Online Module Change Conditions .....	7 - 2
7.2	Online Module Change Operations .....	7 - 3
7.3	Online Module Change Procedure .....	7 - 4
7.3.1	When industrial shipment setting is used and initial setting was made with GX Configurator-DA .....	7 - 4
7.3.2	When industrial shipment setting is used and initial setting was made with sequence program .....	7 - 9
7.3.3	When user range setting is used and initial setting was made with GX Configurator-DA (other system is available).....	7 - 15
7.3.4	When user range setting is used and initial setting was made with GX Configurator-DA (other system is unavailable).....	7 - 20
7.3.5	When user range setting is used and initial setting was made with sequence program (other system is available).....	7 - 26
7.3.6	When user range setting is used and initial setting was made with sequence program (other system is unavailable).....	7 - 31
7.4	Range Reference Table.....	7 - 37
7.5	Precautions for Online Module Change .....	7 - 38

---

## 8 TROUBLESHOOTING

**8 - 1 to 8 - 7**

8.1	Error Code List.....	8 - 1
8.2	Troubleshooting .....	8 - 3
8.2.1	When the "RUN" LED is flashing or turned off.....	8 - 3
8.2.2	When the "ERR." LED is on or flashing .....	8 - 3
8.2.3	When the "ALM" LED is turned on.....	8 - 3
8.2.4	When an analog output value is not output .....	8 - 4

8.2.5	When the analog value is not within the reference accuracy of the theoretical value .....	8 - 5
8.2.6	When analog output value is not "HOLD".....	8 - 5
8.2.7	When External power supply READY (X7) does not turn on.....	8 - 5
8.2.8	Checking the Q66DA-G status using GX Developer system monitor.....	8 - 6

---

## APPENDICES

**App- 1 to App - 11**

---

Appendix 1 Dedicated Instruction List and Available Devices.....	App- 1
Appendix 1.1 G(P).OFFGAN .....	App- 2
Appendix 1.2 G(P).OGLOAD .....	App- 4
Appendix 1.3 G(P).OGSTOR.....	App- 7
Appendix 2 Functions Added or Changed Due to Version Upgrade .....	App- 10
Appendix 3 External Dimensions.....	App- 11

---

## INDEX

**Index - 1 to Index - 2**

---

## **MANUALS**

The manuals related to this product are listed below.  
Please place an order as needed.

### **RELEVANT MANUALS**

<b>Manual name</b>	<b>Manual number (model code)</b>
GX Developer Version 8 Operating Manual Operating methods of GX Developer, such as programming, printing, monitoring, and debugging (Sold separately)	SH-080373E (13JU41)
GX Developer Version 8 Operating Manual (Function Block) Operating methods of GX Developer, such as creating and printing function blocks (Sold separately)	SH-080376E (13JU44)
GX Works2 Version 1 Operating Manual (Common) System configuration, parameter settings, and online operations (common to Simple project and Structured project) of GX Works2 (Sold separately)	SH-080779ENG (13JU63)
GX Works2 Version 1 Operating Manual (Intelligent Function Module) Explains methods of intelligent function module for such as parameter setting, monitoring programs, and predefined protocol support function in GX Works2. (Sold separately)	SH-080921ENG (13JU69)

#### **Remark**

Printed manuals are available separately. Please place an order with the manual number (model code) in the table above.

## **COMPLIANCE WITH EMC AND LOW VOLTAGE DIRECTIVES**

### **(1) Method of ensuring compliance**

To ensure that Mitsubishi Electric programmable controllers maintain EMC and Low Voltage Directives when incorporated into other machinery or equipment, certain measures may be necessary. Please refer to one of the following manuals.

- QCPU User's Manual (Hardware Design, Maintenance and Inspection)
- Safety Guidelines

(This manual is included with the CPU module or base unit.)

The CE mark on the side of the programmable controller indicates compliance with EMC and Low Voltage Directives.

### **(2) Additional measures**

No additional measures are necessary for the compliance of this product with EMC and Low Voltage Directives.

## **GENERIC TERMS AND ABBREVIATIONS**

Unless otherwise specified, this manual uses the following generic terms and abbreviations.

<b>General term/Abbreviation</b>	<b>Description</b>
DOS/V personal computer	An IBM PC/AT <sup>®</sup> or compatible computer with DOS/V
GX Developer	The product name of the software package for the MELSEC programmable controllers
GX Works2	
GX Configurator-DA	The abbreviation for the digital-analog converter module setting and monitor tool GX Configurator-DA (SW2D5C-QDAU-E)
QCPU (Q mode)	A generic term for Basic model QCPU, High Performance model QCPU, Process CPU, Redundant CPU, and Universal model QCPU
Basic model QCPU	A generic term for the Q00JCPU, Q00CPU, and Q01CPU
High Performance model QCPU	A generic term for the Q02CPU, Q02HCPU, Q06HCPU, Q12HCPU, and Q25HCPU
Process CPU	A generic term for the Q02PHCPU, Q06PHCPU, Q12PHCPU, and Q25PHCPU
Redundant CPU	A generic term for the Q12PRHCPU and Q25PRHCPU
Universal model QCPU	A generic term for the Q00UJCPU, Q00UCPU, Q01UCPU, Q02UCPU, Q03UDCPU, Q03UDVCPU, Q03UDECPU, Q04UDHCPU, Q04UDVCPU, Q04UDEHCPU, Q06UDHCPU, Q06UDVCPU, Q06UDEHCPU, Q10UDHCPU, Q10UDEHCPU, Q13UDHCPU, Q13UDVCPU, Q13UDEHCPU, Q20UDHCPU, Q20UDEHCPU, Q26UDHCPU, Q26UDVCPU, Q26UDEHCPU, Q50UDEHCPU, and Q100UDEHCPU
Personal computer	A generic term for DOS/V personal computers
Industrial shipment setting	A generic term for analog output ranges 0 to 5V, 1 to 5V, -10 to 10V, 0 to 20mA, and 4 to 20mA
FB	The abbreviation for function block

## **PACKING LIST**

The product package contains the following.

<b>Model</b>	<b>Product</b>	<b>Quantity</b>
Q66DA-G	Q66DA-G Channel Isolated Digital-Analog Converter module	1
SW2D5C-QDAU-E	GX Configurator-DA Version 2 (single license product) (CD-ROM)	1
SW2D5C-QDAU-EA	GX Configurator-DA Version 2 (volume license product) (CD-ROM)	1

## 1 OVERVIEW

---

This User's Manual describes the specifications, handling and programming methods for the Q66DA-G type channel isolated digital-analog converter module (hereinafter referred to as the Q66DA-G) that is used in combination with a MELSEC-Q series CPU module (hereinafter referred to as the programmable controller CPU).

### 1.1 Features

---

**(1) Multi-channel analog input is available.**

By using a single Q66DA-G, analog voltage or current outputs of 6 points (6 channels) are available.

**(2) Channel isolated**

The channels are isolated from each other and from the external supply power.

**(3) High accuracy**

The reference accuracy\*1 is as high as +0.1% and the temperature coefficient\*2 is as high as -80ppm/°C.

\*1: Accuracy attained at the ambient temperature when offset/gain setting has been made

\*2: Accuracy per temperature change of 1°C

Example) Accuracy when the ambient temperature changed from 25°C to 30°C

$$0.1\% \text{ (reference accuracy)} + 0.008\%/^{\circ}\text{C} \text{ (temperature coefficient)} \times 5^{\circ}\text{C} \text{ (temperature difference)} = 0.14\%$$

**(4) Output range switching**

The output range\*1 switching can be set easily from GX Developer.

\*1: The output range indicates the offset/gain setting type. While the generally used output ranges are available as defaults, the user can set offset/gain values. (Refer to Section 4.5.)

**(5) Analog output HOLD/CLEAR function**

This function is used to set whether to hold or clear the analog output value when the CPU module is stopped or when a stop error occurs. (Refer to Section 3.2.1.)

**(6) Changing the resolution mode**

The resolution mode can be changed according to the application, and digital value resolution settings of 1/4000, 1/12000 or 1/16000 can be selected. (Refer to Section 4.5)



## (7) Warning output function

A warning is output if a digital input value falls outside the setting range. (Refer to Section 3.2.4.)

## (8) Rate control function

The increase and decrease in analog output values per  $6\text{ms}^{*1}$  can be limited, preventing rapid change of the values. (Refer to Section 3.2.4.)

\*1 6ms is the conversion cycle per channel.

## (9) Scaling function

The digital input value range can be changed to any given range between  $-32000$  and  $32000$ , and digital values within the range are converted to analog values. (Refer to Section 3.2.5.)

## (10) Online module change

The module can be changed without the system being stopped.

Further, the existing specifications can be applied to the new system by using sequence programs and performing the following:

- Succession of offset/gain settings to the new Q66DA-G
- Transfer of offset/gain setting values to the other Q66DA-Gs mounted on the other slots

## (11) Offset/gain setting

GX Configurator-DA, dedicated instruction (G(P). OFFGAN) or Mode switching setting allows a shift to the offset/gain setting mode easily. (Refer to Section 4.6.)

## (12) Easy setting with GX Configurator-DA

The number of sequence programs can be reduced since GX Configurator-DA (sold separately) allows the Q66DA-G settings on the dialog box.

Also, GX Configurator-DA simplifies checking of the module settings and operation status.

In addition, FB<sup>\*1</sup> can be automatically created from intelligent function module parameters set in advance to use them for in a sequence program. (Refer to Chapter 5.)

\*1 FB stands for function block, which is a function for setting repeatedly-used circuit blocks as a component and using it in the sequence program.

This function can increase the efficiency of program development and minimize program bugs to improve program qualities.

For the details of FB, refer to "GX Developer Version 8 Operating Manual (Function Block)".

## 2 SYSTEM CONFIGURATION

---

This chapter explains the system configuration of the Q66DA-G.

### 2.1 Applicable Systems

---

This section describes the applicable systems.

#### (1) Applicable modules and base units, and No. of modules

##### (a) When mounted with a CPU module

For the applicable modules, the number of modules, and base units applicable to the Q66DA-G, refer to the user's manual for the CPU module used.

Note the following when the Q66DA-G is mounted with a CPU module.

- Depending on the combination with other modules or the number of mounted modules, power supply capacity may be insufficient. Pay attention to the power supply capacity before mounting modules, and if the power supply capacity is insufficient, change the combination of modules.
- Mount a module within the number of I/O points for the CPU module, If the number of slots is within the available range, the module can be mounted on any slot.

#### Remark

When the module is used with a C Controller module, refer to the user's manual for the C Controller module.

##### (b) Mounting to a MELSECNET/H remote I/O station

For the MELSECNET/H remote I/O station, the number of modules, and base units applicable to the Q66DA-G, refer to the Q Corresponding MELSECNET/H Network System Reference Manual (Remote I/O network).

#### (2) Support of the multiple CPU system

When using the Q66DA-G in a multiple CPU system, refer to the following manual first.

- QCPU User's Manual (Multiple CPU System)

#### (3) Support of online module change

The function version of the Q66DA-G has been "C" from the first release, supporting online module change.

For procedures of the online module change, refer to Chapter7.

## (4) Supported software packages

Relation between the system containing the Q66DA-G and software package is shown in the following table.

GX Developer or GX Works2 are necessary when using the Q66DA-G.

		Software Version		
		GX Developer	GX Configurator-DA	GX Works2
Q00J/Q00/Q01CPU	Single CPU system	Version 7 or later	Version 2.06G or later	Refer to the GX Works2 Version 1 Operating Manual (Common).
	Multiple CPU system	Version 8 or later		
Q02/Q02H/Q06H/ Q12H/Q25HCPU	Single CPU system	Version 4 or later		
	Multiple CPU system	Version 6 or later		
Q02PH/Q06PHCPU	Single CPU system	Version 8.68W or later		
	Multiple CPU system			
Q12PH/Q25PHCPU	Single CPU system	Version 7.10L or later		
	Multiple CPU system			
Q12PRH/ Q25PRHCPU	Redundant CPU system	Version 8.45X or later		
Q00UJ/Q00U/ Q01UCPU	Single CPU system	Version 8.78G or later		
	Multiple CPU system			
Q02U/Q03UD/ Q04UDH/ Q06UDHCPU	Single CPU system	Version 8.48A or later		
	Multiple CPU system			
Q10UDH/ Q20UDHCPU	Single CPU system	Version 8.78G or later		
	Multiple CPU system			
Q13UDH/ Q26UDHCPU	Single CPU system	Version 8.62Q or later		
	Multiple CPU system			
Q03UDE/ Q04UDEH/ Q06UDEH/ Q13UDEH/ Q26UDEHCPU	Single CPU system	Version 8.68W or later		
	Multiple CPU system			
Q10UDEH/ Q20UDEHCPU	Single CPU system	Version 8.78G or later		
	Multiple CPU system			
CPU modules other than the above	Single CPU system	Not supported	Not supported	
	Multiple CPU system	Not supported	Not supported	
If installed in a MELSECNET/H remote I/O station		Version 6 or later	Version 2.06G or later	

## ☒ Point

When using GX Works2, refer to the following.

- GX Works2 Version 1 Operating Manual (Common)
- GX Works2 Version 1 Operating Manual (Intelligent Function Module)

## 2.2 Precautions on System Configuration

### (1) Using Q66DA-G with Redundant CPU

(a) Dedicated instructions

Dedicated instructions cannot be used.

(b) GX Configurator-DA

GX Configurator-DA cannot be used when accessing the Redundant CPU via an intelligent function module on an extension base unit from GX Developer.

Connect a personal computer to the Redundant CPU with a communication path indicated below.

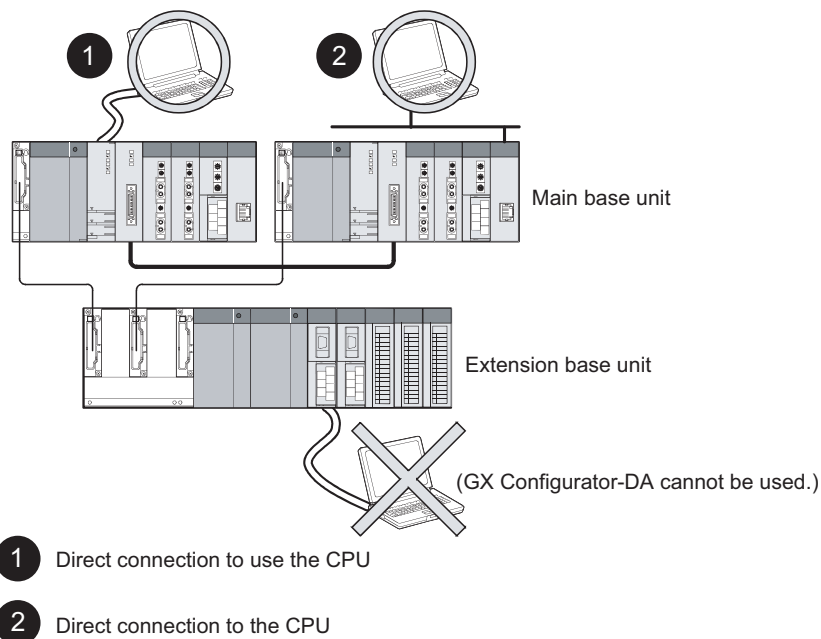

## 2.3 Checking Function Version, Serial Number and Software Version

### (1) Checking the function version and serial number of the Q66DA-G

The serial number and function version of the Q66DA-G are described in the rating plate, on the front part of the module, or displayed in the system monitor dialog box of GX Developer.

(a) Checking on the rating plate located on the side of the Q66DA-G

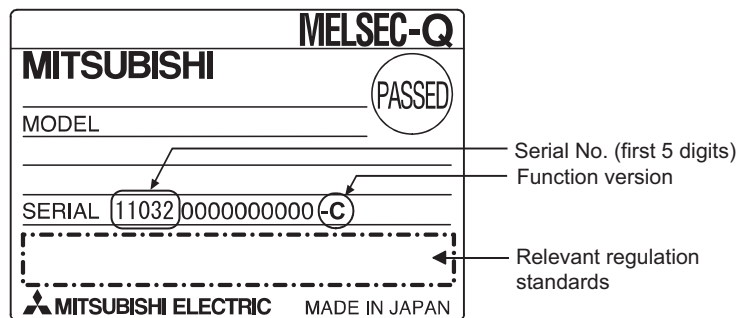

(b) Checking on the front of the module

The serial number and function version on the rating plate is shown on the front (at the bottom) of the module.

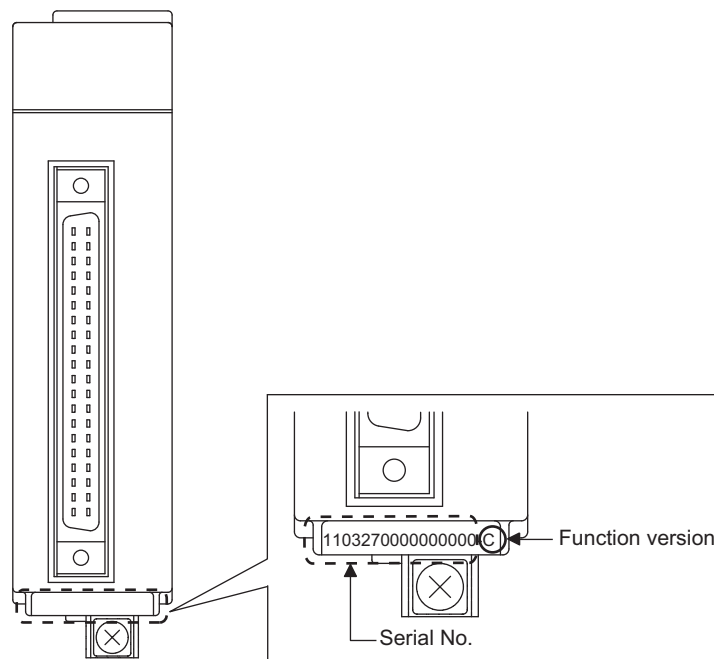

(c) Checking on the System monitor dialog box (Product Information List)

To display the system monitor, select [Diagnostics] → [System monitor] and click the Product Information List button of GX Developer.

Slot	Type	Series	Model name	Points	I/O No.	Master PLC	Serial No.	Ver.	Product No.
PLC	PLC	Q	Q06UDHCPU	-	-	-	1101300000000000	B	091013092955015-B
0-0	Intelli.	Q	Q66DA-G	16pt	0000	-	1103200000000000	C	-
0-1	-	-	None	-	-	-	-	-	-
0-2	-	-	None	-	-	-	-	-	-

### 1) Displaying the product No.

Since the Q66DA-G does not support the display function, "-" is displayed in the "Product No." field.

### ☒ Point

The serial number displayed in the Product Information List dialog box of GX Developer may differ from that on the rating plate and on the front of the module.

- The serial number on the rating plate and front part of the module indicates the management information of the product.
- The serial number displayed in the Product Information List dialog box of GX Developer indicates the function information of the product.

The function information of the product is updated when a new function is added.

## (2) Checking the software version of GX Configurator-DA

The software version of GX Configurator-DA can be checked by selecting [Help]-[Product information] in GX Developer.

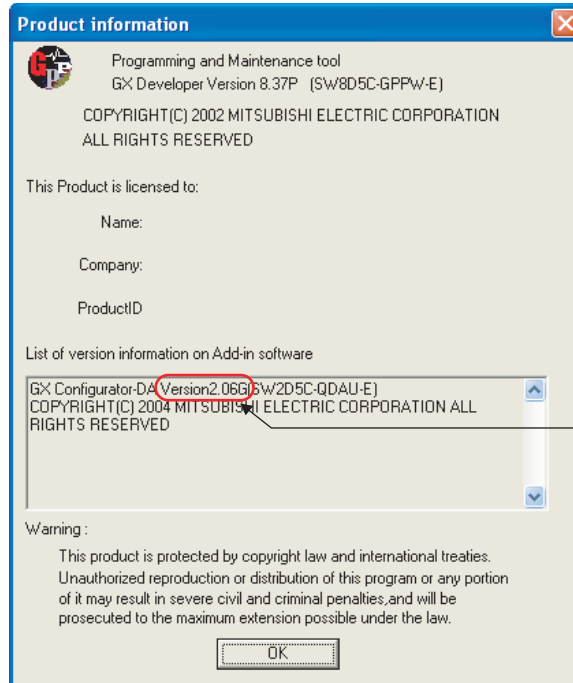

Software version

(In the case of GX Developer Version 8)

## 3 SPECIFICATIONS

### 3.1 Performance Specifications

#### 3.1.1 Performance specifications list

Table3.1 Performance specifications list

Item	Specifications																																																										
Number of analog outputs	6 points (6 channels)																																																										
Digital input	16-bit signed binary (normal resolution mode: -4096 to 4095 high resolution mode: -12288 to 12287, -16384 to 16383)																																																										
Using scaling function	16-bit signed binary (-32768 to 32767)																																																										
Analog output	Voltage	-12 to 12VDC (External load resistance: 1k to 1MΩ)																																																									
	Current	0 to 20mADC (External load resistance: 0 to 600Ω) 0 to 22mADC (External load resistance: Please refer to *3)																																																									
I/O characteristics maximum resolution *4	<table border="1"> <thead> <tr> <th rowspan="2">Analog output range</th> <th colspan="2">Normal resolution mode</th> <th colspan="2">High resolution mode</th> </tr> <tr> <th>Digital input value</th> <th>Maximum resolution</th> <th>Digital input value</th> <th>Maximum resolution</th> </tr> </thead> <tbody> <tr> <td rowspan="6">Voltage</td> <td>0 to 5V</td> <td rowspan="2">0 to 4000</td> <td>1.25mV</td> <td rowspan="2">0 to 12000</td> <td>0.416mV</td> </tr> <tr> <td>1 to 5V</td> <td>1.0mV</td> <td>0.333mV</td> </tr> <tr> <td>-10 to 10V</td> <td>-4000 to 4000</td> <td>2.5mV</td> <td>-16000 to 16000</td> <td>0.625mV</td> </tr> <tr> <td>1 to 5V (Extended mode) *5</td> <td>-1000 to 4500</td> <td>1.0mV</td> <td>-3000 to 13500</td> <td>0.333mV</td> </tr> <tr> <td>User range setting 2</td> <td rowspan="2">-4000 to 4000</td> <td>0.75mV</td> <td rowspan="2">-12000 to 12000</td> <td>0.400mV</td> </tr> <tr> <td>User range setting 3</td> <td>0.375mV</td> <td>0.210mV</td> </tr> <tr> <td rowspan="5">Current</td> <td>0 to 20mA</td> <td rowspan="2">0 to 4000</td> <td>5μA</td> <td rowspan="2">0 to 12000</td> <td>1.66μA</td> </tr> <tr> <td>4 to 20mA</td> <td>4μA</td> <td>1.33μA</td> </tr> <tr> <td>4 to 20mA (Extended mode) *5</td> <td>-1000 to 4500</td> <td>4μA</td> <td>-3000 to 13500</td> <td>1.33μA</td> </tr> <tr> <td>User range setting 1</td> <td>-4000 to 4000</td> <td>1.5μA</td> <td>-12000 to 12000</td> <td>0.95μA</td> </tr> </tbody> </table>				Analog output range	Normal resolution mode		High resolution mode		Digital input value	Maximum resolution	Digital input value	Maximum resolution	Voltage	0 to 5V	0 to 4000	1.25mV	0 to 12000	0.416mV	1 to 5V	1.0mV	0.333mV	-10 to 10V	-4000 to 4000	2.5mV	-16000 to 16000	0.625mV	1 to 5V (Extended mode) *5	-1000 to 4500	1.0mV	-3000 to 13500	0.333mV	User range setting 2	-4000 to 4000	0.75mV	-12000 to 12000	0.400mV	User range setting 3	0.375mV	0.210mV	Current	0 to 20mA	0 to 4000	5μA	0 to 12000	1.66μA	4 to 20mA	4μA	1.33μA	4 to 20mA (Extended mode) *5	-1000 to 4500	4μA	-3000 to 13500	1.33μA	User range setting 1	-4000 to 4000	1.5μA	-12000 to 12000	0.95μA
	Analog output range	Normal resolution mode		High resolution mode																																																							
		Digital input value	Maximum resolution	Digital input value	Maximum resolution																																																						
	Voltage	0 to 5V	0 to 4000	1.25mV	0 to 12000	0.416mV																																																					
		1 to 5V		1.0mV		0.333mV																																																					
		-10 to 10V	-4000 to 4000	2.5mV	-16000 to 16000	0.625mV																																																					
		1 to 5V (Extended mode) *5	-1000 to 4500	1.0mV	-3000 to 13500	0.333mV																																																					
		User range setting 2	-4000 to 4000	0.75mV	-12000 to 12000	0.400mV																																																					
		User range setting 3		0.375mV		0.210mV																																																					
	Current	0 to 20mA	0 to 4000	5μA	0 to 12000	1.66μA																																																					
		4 to 20mA		4μA		1.33μA																																																					
		4 to 20mA (Extended mode) *5	-1000 to 4500	4μA	-3000 to 13500	1.33μA																																																					
User range setting 1		-4000 to 4000	1.5μA	-12000 to 12000	0.95μA																																																						
Accuracy (Accuracy relative to maximum analog output value)		Reference accuracy *1	± 0.1% (Voltage: ±10mV, Current: ±20μA)																																																								
	Temperature coefficient *2	±80ppm/ °C (0.008%/ °C)																																																									
Conversion speed	6ms/ channels																																																										
Absolute maximum output	Voltage	±13V																																																									
	Current	23mA																																																									
Maximum number of writes to flash memory	Up to 50,000 times																																																										
Output short-circuit protection	Available																																																										
Isolation specifications	Specific isolated area		Isolation method	Dielectric withstand Voltage	Insulation resistance																																																						
	Between the output terminal and programmable controller power supply		Transformer isolation	500VAC rms, 1min	500VDC 10MΩ or more																																																						
	Between analog output channels			1000VAC rms, 1min																																																							
	Between external supply power and analog output channel			500VAC rms, 1min																																																							
Number of I/O occupied points	16 points (I/O assignment: Intelligent 16 points)																																																										
External wiring connection system	40-pin connector																																																										
Applicable wire size	0.3mm <sup>2</sup> (22 AWG) or less (for A6CON1, A6CON4)																																																										
	0.088mm <sup>2</sup> to 0.24mm <sup>2</sup> (28 to 24 AWG) (for A6CON2)																																																										
Connectors for external devices	A6CON1,A6CON2,A6CON4 (Sold separately)																																																										



Table3.1 Performance specifications list

Item	Specifications
External supply power	24VDC, +20%, -15%
	Ripple, spike within 500 mVP-P
	Inrush current: 4.8A, within 400 $\mu$ s
Internal current consumption (5 VDC)	0.22A
Weight	0.62A
	0.22kg

- \*1 Accuracy of offset/gain setting at ambient temperature  
The Q66DA-G needs to be powered on 30 minutes prior to operation for compliance to the specification (accuracy).
- \*2 Accuracy per temperature change of 1 °C  
Example: Accuracy when temperature changes from 25 to 30 °C  
0.1% (Reference accuracy) + 0.008%/ °C (temperature coefficient)  $\times$  5 °C (temperature change difference) = 0.14%
- \*3 The following indicates the external load resistance when output current is 20mA or more.

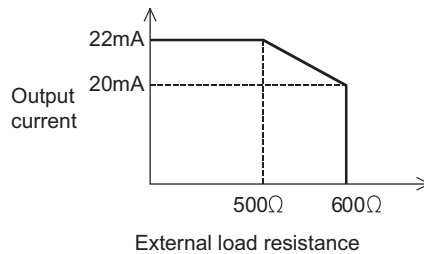

- \*4 For the details of the I/O conversion characteristic, refer to Section 3.2.1.
- \*5 GX Configurator-DA is not available with extended mode range settings.

**Remark**

Refer to the user's manual for the CPU module being used for the general specifications for the Q66DA-G.

### 3.1.2 I/O conversion characteristics

I/O conversion characteristics are used for converting the digital value written from the programmable controller CPU to an analog output value (voltage or current output), and represented by inclined straight lines when offset and gain values are included.

**Offset value**

The offset value is an analog output value (voltage or current) when a digital input value set from the programmable controller CPU is 0.

**Gain value**

The gain value is an analog output value (voltage or current) when a digital input value set from the programmable controller CPU is 4000 (in normal resolution mode), 12000 (when 1 to 5V, 0 to 5V, 4 to 20 mA, 0 to 20 mA or the user range setting 1 to 3 is selected in high resolution mode), or 16000 (when -10 to 10V is selected in high resolution mode).

## (1) Voltage output characteristic

Fig3.1 shows a graph of the voltage output characteristic.

1) 1 to 5V

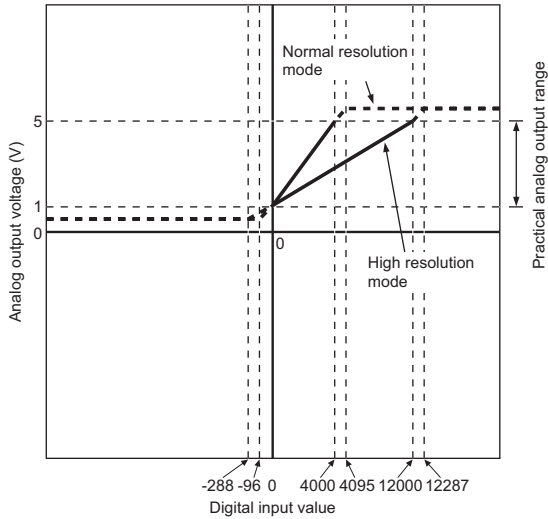

2) 0 to 5V

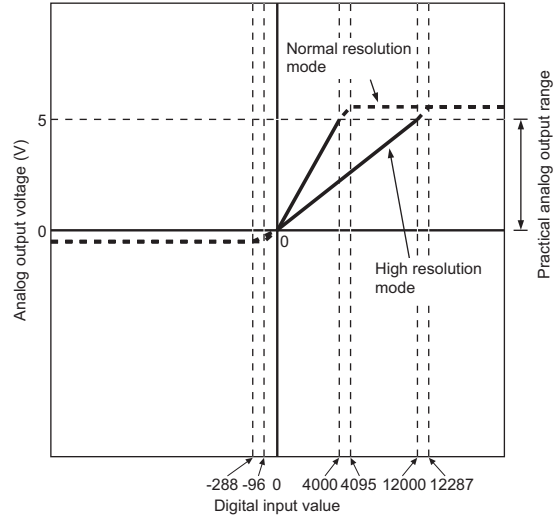

3) -10 to 10V

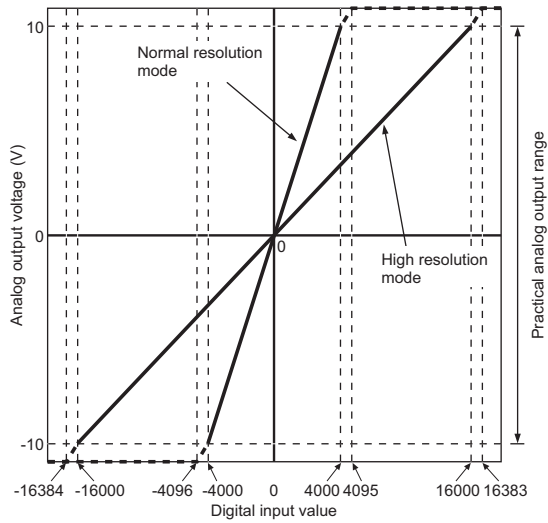

4) 1 to 5V (Expanded mode)

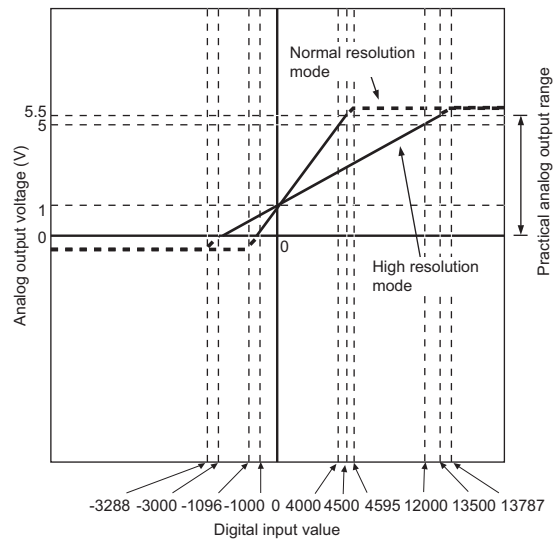

Fig3.1 Voltage output characteristic (1/2)

## ☒ Point

- (1) Use the module within the digital input range and analog output range for each output range setting.  
If these ranges are exceeded, the maximum resolution and accuracy may not fall within the performance specifications. (Avoid using the dotted line area shown in Fig3.1.)

- (2) In user range setting 3, the maximum and minimum output values are 6V and -6V respectively. Obtain these values as follows using the gain and offset values.

Maximum analog output value = Gain value

Minimum analog output value = (Offset value - (Gain value - Offset value))

If a maximum or minimum value exceeds the output range, use user range setting 2.

- (3) Set the offset/gain values for the user range setting 2 within a range in which the following conditions are satisfied.

(a) Setting range is from -12 to 12 V.

(b)  $\{ (\text{Gain value}) - (\text{Offset value}) \} > A$   
<Value of A>

Normal resolution mode	High resolution mode
3.0V	5.0V

- (4) Set the offset/gain values for the user range setting 3 within a range in which the following conditions are satisfied.

(a) Setting range is from -0.5 to 6 V.

(b)  $\{ (\text{Gain value}) - (\text{Offset value}) \} > A$   
<Value of A>

Normal resolution mode	High resolution mode
1.5V	2.6V

## (2) Current output characteristic

Fig3.2 shows a graph of the current output characteristic.

1) 4 to 20mA

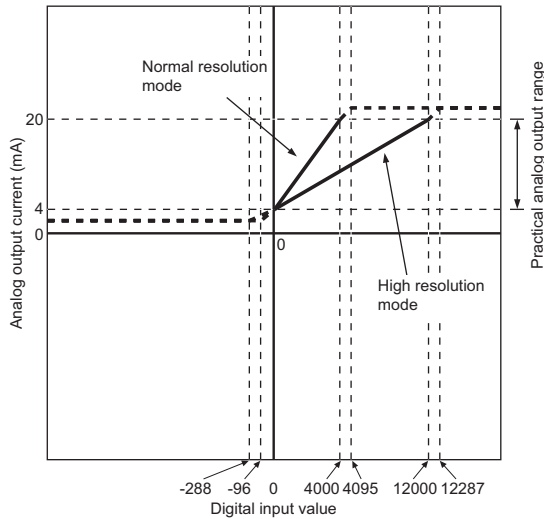

2) 0 to 20mA

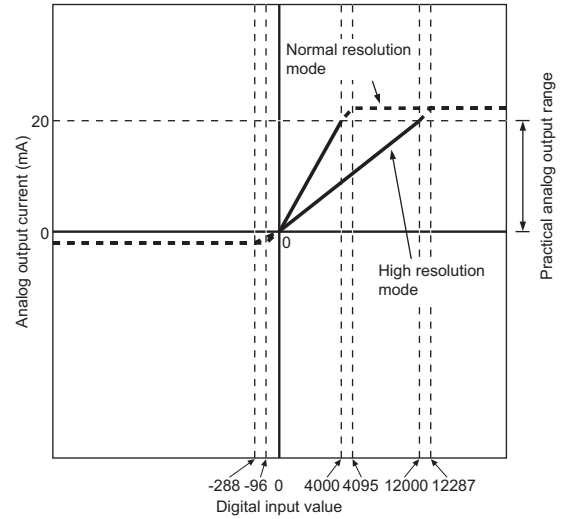

3) 4 to 20mA (Expanded mode)

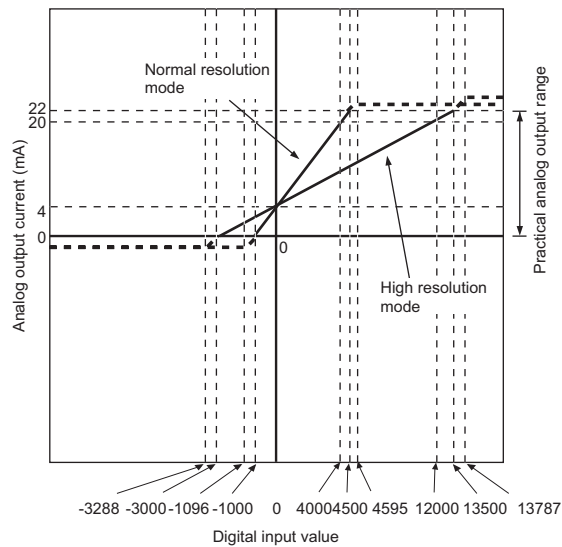

Fig3.2 Current output characteristic

## ☒ Point

- (1) Use the module within the digital input range and analog output range for each output range setting.  
If these ranges are exceeded, the maximum resolution and accuracy may not fall within the performance specifications. (Avoid using the dotted line area shown in Fig3.2.)
- (2) Set the offset/gain values for the user range setting 1 within a range in which the following conditions are satisfied.
  - (a) Setting range is from 0 to 22 mA
  - (b)  $\{ (\text{Gain value}) - (\text{Offset value}) \} > A$   
<Value of A>

Normal resolution mode	High resolution mode
6.0mA	11.5mA

## 3.1.3 Accuracy

---

The reference accuracy is the accuracy at the ambient temperature for offset/gain setting.

The temperature coefficient is the accuracy per temperature variation of 1°C .

The reference accuracy is the accuracy relative to the maximum value of the analog output value.

Even if the offset/gain setting or analog output range is changed to change the output characteristic, the reference accuracy and temperature coefficient do not vary and are kept within the ranges given in the performance specifications.

Example) Accuracy when the temperature varies from 25°C to 30°C

$$0.1\% \text{ (reference accuracy)} + 0.008\%/^{\circ}\text{C} \text{ (temperature coefficient)} \times 5^{\circ}\text{C} \text{ (difference in temperature variation)} = 0.14\%$$

## 3.1.4 Conversion speed

---

The conversion speed for the Q66DA-G is "6ms × the number of conversion enabled channels".

By setting the unused channels to D/A conversion disabled (Refer to Section 3.4.2), the conversion speed can be increased.

## 3.2 Function List

Table3.2 shows the functions of the Q66DA-G.

**Table3.2 Function list**

Item	Function	Reference section
D/A conversion enable/disable function	<ul style="list-style-type: none"> <li>Specifies whether to enable or disable the D/A conversion for each channel.</li> <li>Disabling D/A conversion of unused channels can increase the conversion speed.</li> </ul>	Section 3.4.2
D/A output enable/disable function	<ul style="list-style-type: none"> <li>Specifies whether to output the D/A converted value or output the offset value for each channel.</li> <li>Regardless of the output enable/disable setting, the conversion speed is "6ms x number of conversion-enabled channels".</li> </ul>	Section 3.3.1
Analog output HOLD/CLEAR function	<ul style="list-style-type: none"> <li>The output analog value can be retained when the programmable controller CPU is placed in the STOP status or when an error occurs.</li> </ul>	Section 3.2.1
Analog output test during programmable controller CPU STOP	<ul style="list-style-type: none"> <li>When CH□ Output enable/disable flag (Y1 to Y6) is forced on during programmable controller CPU STOP, the D/A converted analog value is output.</li> </ul>	Section 3.2.2
Warning output function	<ul style="list-style-type: none"> <li>A warning is output if a digital input value falls outside the setting range.</li> </ul>	Section 3.2.3
Rate control function	<ul style="list-style-type: none"> <li>The increase and decrease in analog output values per conversion cycle of one station (6ms) can be limited.</li> <li>Using this function prevents rapid change of analog output values.</li> </ul>	Section 3.2.4
Resolution mode	<ul style="list-style-type: none"> <li>The resolution mode can be changed according to the application, and a resolution setting can be selected from 1/4000, 1/12000 and 1/16000.</li> <li>The resolution mode setting is applicable to all channels in block.</li> <li>Refer to Section 3.1.1 for the digital input values and maximum resolution in normal resolution mode and high resolution mode.</li> </ul>	Section 3.1.1 Section 4.5
Scaling function	<ul style="list-style-type: none"> <li>The input range of digital values can be changed to any given range between -32000 and 32000.</li> </ul>	Section 3.2.5
Online module change	<ul style="list-style-type: none"> <li>The module can be changed without the system being stopped.</li> </ul> <p>However, if a module in the analog output range extended mode is replaced with a module that does not support the mode, an intelligent function module switch error occurs.</p>	Chapter 7

## 3.2.1 Analog output HOLD/CLEAR function

- (1) For the case where the programmable controller CPU is placed in STOP or in a stop error status, whether to hold (HOLD) or clear (CLEAR) the analog output value can be set.
- (2) Set HOLD or CLEAR in "Switch 3" (HOLD/CLEAR function setting) of Switch setting for I/O and intelligent function module dialog box. (Refer to Section 4.5 (1).)
- (3) Depending on combinations of the HOLD/CLEAR setting, D/A conversion enable/disable setting (Un\G0), and CH□ Output enable/disable flag (Y1 to Y6), the analog output status varies as shown in Table 3.3.

Table 3.3 Analog output status combination list

Setting combination Execution status	D/A conversion enable/disable setting (Un\G0)	Enable			Disable
	CH□ Output enable/disable flag (Y1 to Y6)	Enable		Disable	Enable or disable
	HOLD/CLEAR setting	HOLD	CLEAR	HOLD or CLEAR	HOLD or CLEAR
Analog output status when programmable controller CPU is RUN		Outputs analog values converted from digital values. *2		Offset	0 V/0 mA
Analog output status when programmable controller CPU is STOP		Hold	Offset	Offset	0 V/0 mA
Analog output status when a programmable controller CPU stop error occurs		Hold	Offset	Offset	0 V/0 mA
Analog output status when a watchdog timer error *1 occurs in Q66DA-G		0 V/0 mA	0 V/0 mA	0 V/0 mA	0 V/0 mA

\*1 This occurs when program operations are not completed within the scheduled time due to a hardware problem of the Q66DA-G. When a watchdog timer error occurs, Module READY (X0) turns off and the Q66DA-G RUN LED turns off.

\*2 The rate control function and the scaling function are operable.



## ☒ Point

The following conditions should be satisfied when the analog output HOLD/CLEAR function is used on a MELSECNET/H remote I/O station.

- The master module of function version D or later and the remote I/O module of function version D or later are required.
- Validate the station unit block guarantee of the send side cyclic data.
- The setting for holding the Q66DA-G output in the case of a link error must be made in the "Error time output mode in the I/O assignment setting". (Refer to Section 4.5 (2).) The HOLD/CLEAR setting by the intelligent function module switch is invalid. This setting is validated on a per-module basis, and is not made on a per-channel basis. Therefore, to make the output status at a stop error or STOP of the programmable controller CPU matched with the output status at a link error, set the same. HOLD/CLEAR setting to all channels. (Refer to the table below.)

	Error time output mode	HOLD/CLEAR setting (Same setting to all channels)
Hold analog output	Hold	HOLD
Clear analog output (Output offset value)	Clear	CLEAR

For the station unit block guarantee of the cyclic data, refer to the Q Corresponding MELSECNET/H Network System Reference Manual (Remote I/O Network).

## 3.2.2 Analog output test during programmable controller CPU STOP

- (1) While the programmable controller CPU is in STOP, an analog output test as shown in Table3.4 can be performed.
- (2) To conduct an analog output test, perform the following on Device test of GX Developer or on the relevant test screens of Configurator-DA (Refer to Section 5.6.1.).
  - (a) Set D/A conversion enable/disable setting (Un\G0) of the channel to be tested to enable.
  - (b) Turn on Operating condition setting request (Y9).
  - (c) Check that Operating condition setting completed flag (X9) has turned off. Then turn off Operating condition setting request (Y9).
  - (d) Sets CH□ Output enable/disable flag (Y1 to Y6) for the channel to be tested to enable (off → on).
  - (e) Write digital values equivalent to analog values that are to be output to CH□ Digital value (Un\G1 to Un\G6).

Table3.4 List of analog output test

Setting combination	D/A conversion enable/disable setting (Un\G0)	Enable		Disable	
	CH□ Output enable/disable flags (Y1 to Y6)	Enable	Disable	Enable	Disable
	Analog output test	Allowed	Not allowed	Not allowed *1	

\*1 Perform the analog output test after changing D/A conversion enable/disable setting (Un\G0) to enable.

### ☒ Point

When the digital input value is set to be written to CH□ Digital value (Un\G1 to Un\G6) from the CPU device at the automatic refresh setting of GX Configurator-DA, write digital input value to the CPU device where the setting is performed. The automatic refresh can be performed while the programmable controller CPU is in STOP.

## 3.2.3 Warning output function

- (1) If a digital input value is greater than the warning output upper limit value or less than the warning output lower limit value, Warning output flag (Un\G48), Warning output signal (XE), and the ALM LED will turn on, informing the warning. Warning is output for a D/A-conversion-enabled channel only.
- (2) The analog output value of warning occurrence is the value converted from the digital input value at the warning output upper limit value or warning output lower limit value.
- (3) Warning output flag (Un\G48) and Warning output signal (XE) turn off when Operating condition setting request (Y9) or Warning output clear request (YE) turns on.
- (4) To use this function, the following settings are required for each setting.
  - Enable the warning output function: Warning output setting (Un\G47)
  - Set the warning output upper and lower limit values: CH□ Warning output upper/lower limit values (Un\G86 to Un\G97)

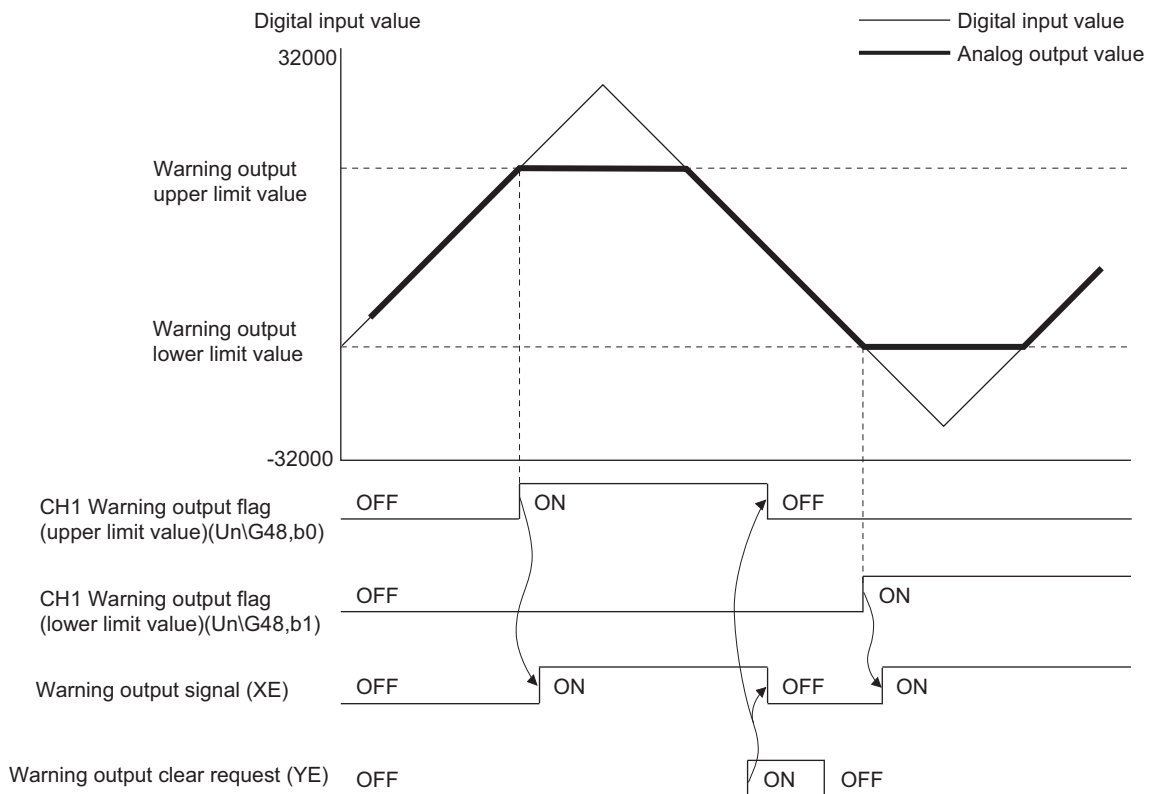

- (5) When the scaling function is used, input values converted within the scaling range are checked for warning output.

---

## ☒ Point

- (1) If a warning is output immediately after D/A conversion is enabled, make Warning output clear request after writing a digital value that is less than the warning output upper limit value and greater than the warning output lower limit value.
  - (2) During an analog output test, the warning output function is disable.
-

## 3.2.4 Rate control function

- (1) The increase and decrease in analog output values per  $6\text{ms}^{*1}$  can be limited, which can prevent rapid change of the values.

\*1 6ms is the D/A conversion cycle per channel.

- (2) To use this function, the following settings are required for each setting.
- Enable the rate control function: Rate control enable/disable setting (Un\G46)
  - Set the increase/decrease of analog output value per 6ms: CH□ Increase/decrease digital limit value (Un\G70 to Un\G81)

- (3) Although values on a per-6ms basis are set in CH□ Increase/decrease digital limit value (Un\G70 to Un\G81), the actual cycle in which the Q66DA-G updates analog values is (6ms x number of conversion-enabled channels). Therefore, the maximum increase/decrease in analog output values under the rate control is a D/A converted value of (Increase/decrease digital limit value x No. of conversion-enabled channels).

[Example Control of channel 3 when No. of conversion-enabled channels is 1 to 3]

- Output range: -10 to 10V
- Increase digital limit value: 100
- Decrease digital limit value: 100

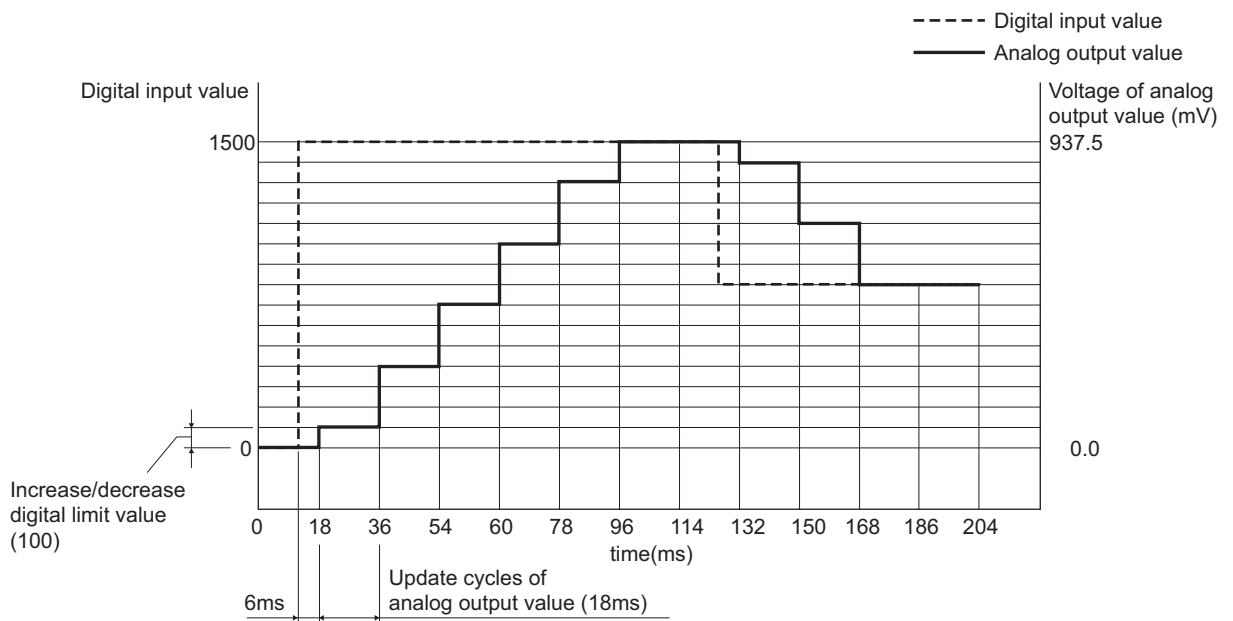

When the digital input value changes, the analog output value increases or decreases in update cycles as follows:

- 1st time: D/A converted value of the upper/lower digital limit value
- 2nd time or later: D/A converted value of (Increase/decrease digital limit value x No. of conversion-enabled channels)

- (4) If the operation of the programmable controller CPU varies at the setting of D/A conversion enable, D/A output enable and analog output CLEAR, the rate control functions operate as indicated below.
- If the programmable controller CPU has switched from RUN to STOP (error):  
Rate control does not function.
  - If the programmable controller CPU has switched from STOP (error) to RUN:  
Rate control functions.

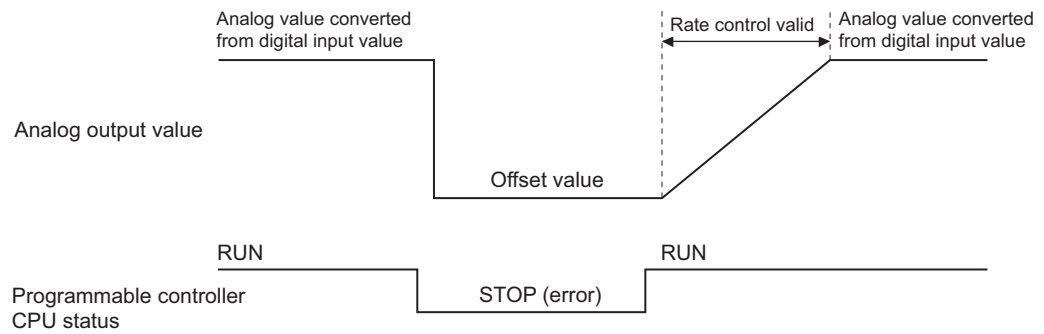

- (5) When the scaling function is used, digital input values converted within the scaling range are limited.

## 3.2.5 Scaling function

The digital input value range can be changed to any given range between -32000 and 32000.

To use this function, the following settings are required for each channel.

- Enable the scaling function: Scaling enable/disable setting (Un\G53)
- Set the scaling upper and lower limit values: CH□ Scaling upper/lower limit value (Un\G54 to Un\G65)

CH□ Scaling upper/lower limit value setting vary depending on the output range. (Refer to (1) and (2) below.)

### (1) When using the factory default setting for the output range

- (a) As the scaling upper and lower limit values, set digital values equivalent to the upper and lower limit values of analog output respectively.

[Example] When the output range is “0 to 5V”      [Example] When the output range is “-10 to 10V”

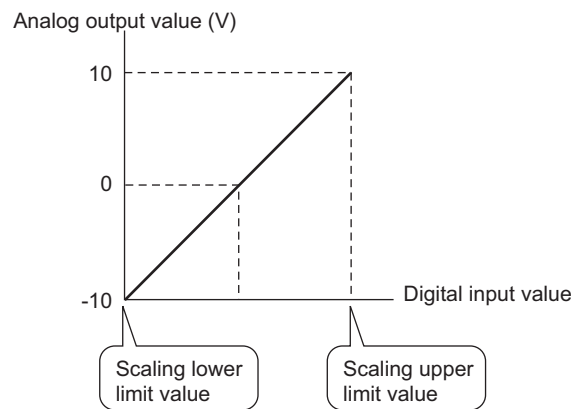
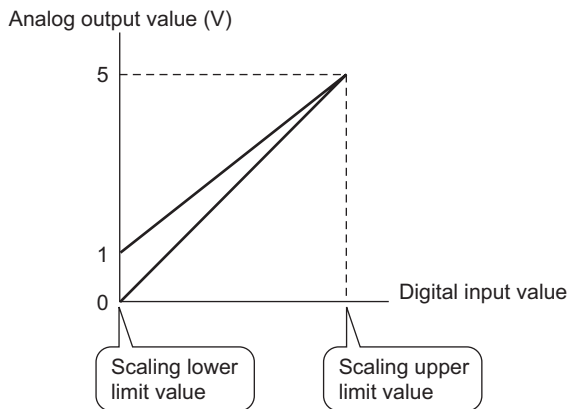

- (b) The D/A conversion uses values calculated from the following formula.

$$\text{Digital values actually used for D/A conversion} = \frac{D_{\text{Max}} - D_{\text{Min}}}{S_{\text{H}} - S_{\text{L}}} \times (D_{\text{x}} - S_{\text{L}}) + D_{\text{Min}}$$

- $D_{\text{x}}$  : Digital input value  
 $D_{\text{Max}}$  : Maximum digital input value of the output range used  
 $D_{\text{Min}}$  : Minimum digital input value of the output range used  
 $S_{\text{H}}$  : Scaling upper limit value  
 $S_{\text{L}}$  : Scaling lower limit value

[Example]

When a digital input value of 7000 is input under the following setting:  
 Output range: -10 to 10V, High resolution mode,  
 Scaling upper limit value: 14000, Scaling lower limit value: 2000

Digital values actually used for D/A conversion

$$= \frac{16000 - (-16000)}{14000 - 2000} \times (7000 - 2000) + (-16000)$$

$$= -2666.66 \dots$$

$$= -2666$$

Fractional part is rounded down.

## (2) When using the user range setting for the output range

- (a) Set a digital value, which is equivalent to the analog gain value to be output, as the scaling upper limit value. Also, set a digital value, which is equivalent to the analog offset value to be output, as the scaling lower limit value.

[Example] User range setting 2, Offset value: 1V, Gain value: 8V

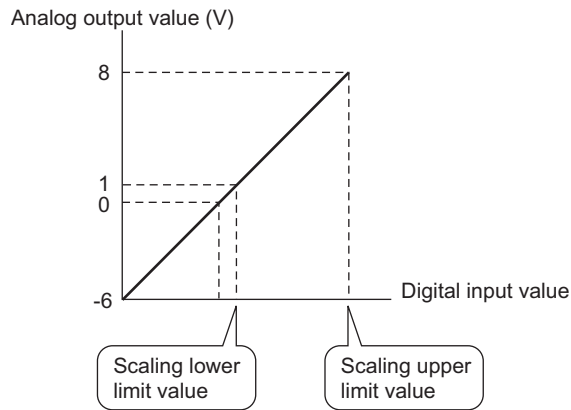

- (b) The D/A conversion uses values calculated from the following formula.

$$\text{Digital values actually used for D/A conversion} = \frac{D_{\text{Max}}}{S_{\text{H}} - S_{\text{L}}} \times (D_{\text{x}} - S_{\text{L}})$$

$D_{\text{x}}$  : Digital input value

$D_{\text{Max}}$ : Maximum digital input value of the output range used

$S_{\text{H}}$  : Scaling upper limit value

$S_{\text{L}}$  : Scaling lower limit value

[Example]

When a digital input value of 4000 is input under the following setting:

Output range: User range setting 2, High resolution mode,

Scaling upper limit value: 13000, Scaling lower limit value: 2000

Digital values actually used for D/A conversion

$$\begin{aligned} &= \frac{12000}{13000 - 2000} \times (4000 - 2000) \\ &= 2181.81 \dots \dots \\ &= 2181 \end{aligned}$$

Fractional part is rounded down.



## ☒ Point

- (1) Even if the digital value input range is enlarged, the resolution will not be more than the one applied when the scaling function is not used. As the digital value input range is narrowed, the resolution is lowered.
- (2) When a digital value input range not including zero (0), such as "1000 to 6000", is specified, turn on CH□ Output enable/disable flag (Y1 to Y6) after setting values within the input range in CH□ Digital value (Un\G1 to Un\G6). If CH□ Output enable/disable flag (Y1 to Y6) is turned on with the default value (0) set in CH□ Digital value (Un\G1 to Un\G6), an error will occur and an error code will be stored in Error code (Un\G19).
- (3) The check of the settable range is performed for "digital values actually used for D/A conversion".
- (4) Depending on whether to use the scaling function or not, the analog output value varies on the boundary between the inside and outside of the digital input value setting range.

[Example 1]

Output range: 4 to 20mA, Normal resolution mode, and not using the scaling function

By the conditions of the output range and resolution mode, the available digital input value setting range is -96 to 4095.

When a digital value is the upper limit of the settable range, 4095 or higher, an analog value equivalent to 4095 is output, which means the same analog value is output for the digital values within and outside the setting range.

[Example 2]

Output range: 4 to 20mA, Normal resolution mode (same as Example 1), and using the scaling function with:

Scaling upper limit value: 3000, Scaling lower limit value: 1000

When a digital value is the upper limit of the settable range, 3047 (4094 after calculation), an analog value equivalent to 4094 is output.

On the other hand, if it is out of the settable range, which is 3048 or higher (calculated value is 4096 or higher), an analog value equivalent to 4095 is output.

As a result, the analog output value converted from the upper limit digital value of the settable range is different from the one converted from the value outside the settable range by 1 digit.

- (5) When a gap between the scaling upper and lower limit values is too large in the output range setting of 4 to 20mA (Extended mode) or 1 to 5V (Extended mode), digital values in the extended range may exceed the range of -32768 to 32767 and thus cannot be set.

## 3.3 I/O Signals for the Programmable Controller CPU

### 3.3.1 List of I/O signals

Table 3.5 shows a list of the I/O signals for the Q66DA-G.

Table3.5 List of I/O signal

Signal direction	Q66DA-G → CPU module	Signal direction	CPU module → Q66DA-G
Device No	Signal name	Device No.	Signal name
X0	Module READY	Y0	Use prohibited *1
X1	Use prohibited *1	Y1	CH1 Output enable/disable flag
X2		Y2	CH2 Output enable/disable flag
X3		Y3	CH3 Output enable/disable flag
X4		Y4	CH4 Output enable/disable flag
X5		Y5	CH5 Output enable/disable flag
X6		Y6	CH6 Output enable/disable flag
X7	External power supply READY	Y7	Use prohibited *1
X8	High resolution mode status flag	Y8	
X9	Operating condition setting completed flag	Y9	Operating condition setting request
XA	Offset/gain setting mode flag	YA	User range writing request
XB	Channel change completed flag	YB	Channel change request
XC	Set value change completed flag	YC	Set value change request
XD	Use prohibited *1	YD	Use prohibited *1
XE	Warning output signal	YE	Warning output clear request
XF	Error flag	YF	Error clear request

#### ☒ Point

\*1 These signals cannot be used by the user since they are used by the system. If these are turned on/off by the sequence program, the function of the Q66DA-G cannot be guaranteed.

## 3.3.2 Details of I/O signals



I/O signals for the Q66DA-G are explained in detail below.

### (1) Input signals

Device No.	Signal name	Description
X0	Module READY	<p>(1) When the programmable controller CPU is powered on or reset, this signal turns ON when the initial processings in the Q66DA-G are all completed.</p> <p>(2) When Module READY (X0) signal is off, D/A conversion processing is not performed. Module READY (X0) turns off in the following situations:</p> <ul style="list-style-type: none"> <li>• During offset/gain setting mode</li> <li>• When the Q66DA-G has a watchdog timer error</li> </ul>
X7	External power supply READY	<p>(1) This signal turns on 100ms after turning on the external power supply.</p> <p>(2) In normal mode, when Module READY (X0) is off, this signal does not turn on even if 100ms have elapsed after turning on the external power supply. In this case, as soon as Module READY (X0) turns on, this signal (X7) turns on.</p> <p>(3) In Offset/gain setting mode, when Offset/gain setting mode flag (XA) is off, this signal does not turn on even if 100ms have elapsed after turning on the external power supply. In this case, as soon as Offset/gain setting mode flag (XA) turns on, External power supply READY (X7) turns on.</p> <p>(4) D/A conversion is performed after External power supply READY (X7) turns on.</p> <p>(5) When the external power is not supplied or has been supplied for less than 100ms, X7 is off and no D/A conversion is performed. At this time, the analog output value is "0mA/0V" regardless of other settings, and no invalid digital value error detection or no warning output is performed.</p> <p>(6) X7 might not turn on when the external power supply does not meet the requirements shown in the performance specifications (Refer to Table3.1.).</p> <p>(7) The following time chart shows that the external power supply is turned on after power-on of a programmable controller CPU.</p> <p>(8) When performing D/A output, X0 and X7 must be on as shown below.</p> <pre> Digital value write command X0 X7 [ MOVP K4000 U0\ G1 ]     </pre>
X8	High resolution mode status flag	<p>(1) This turns on at the high resolution mode.</p>

1 OVERVIEW  
2 SYSTEM CONFIGURATION  
3 SPECIFICATIONS  
4 SETUP AND PROCEDURES BEFORE OPERATION  
5 UTILITY PACKAGE (GX CONFIGURATOR-DA)  
6 PROGRAMMING  
7 ONLINE MODULE CHANGE  
8 TROUBLESHOOTING

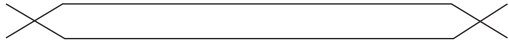
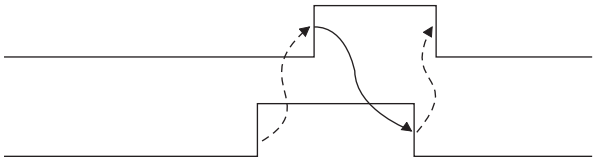
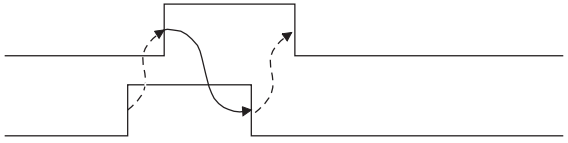
Device No.	Signal name	Description
X9	Operating condition setting completed flag	<p>(1) This is used as an interlock condition for turning on/off Operating condition setting request (Y9) when any of the following settings is changed.</p> <ul style="list-style-type: none"> <li>- D/A conversion enable/disable setting (Un\G0)</li> <li>- Rate control enable/disable setting (Un\G46)</li> <li>- Warning output setting (Un\G47)</li> <li>- Scaling enable/disable setting (Un\G53)</li> <li>- CH <input type="checkbox"/> Scaling upper/lower limit value (Un\G54 to Un\G65)</li> <li>- CH <input type="checkbox"/> Increase/decrease digital limit value (Un\G70 to Un\G81)</li> <li>- CH <input type="checkbox"/> Warning output upper/lower limit value (Un\G86 to Un\G97)</li> </ul> <p>(2) Under the following conditions, Operating condition setting completed flag (X9) turns off.</p> <ul style="list-style-type: none"> <li>- When Operating condition setting request (Y9) is on</li> </ul> <div style="margin-left: 40px;"> <p>-----&gt; Performed by the Q66DA-G</p> <p>—————&gt; Performed by the sequence program</p> </div>
XA	Offset/gain setting mode flag	<p>[In offset/gain setting mode]</p> <p>(1) This is used as an interlock condition for turning on/off User range writing request (YA) when registering the value after adjustment of the offset/gain settings have been completed.</p> <p>(2) Refer to Section 4.6 regarding the offset/gain settings.</p> <div style="margin-left: 40px;"> <p>-----&gt; Performed by the Q66DA-G</p> <p>—————&gt; Performed by the sequence program</p> </div> <p>[In normal mode]</p> <p>(1) This is used as an interlock condition to turn on/off User range writing request (YA) when the user range is restored.</p> <p>(2) Refer to Chapter 7 regarding the user range restoration.</p> <div style="margin-left: 40px;"> <p>-----&gt; Performed by the Q66DA-G</p> <p>—————&gt; Performed by the sequence program</p> </div>

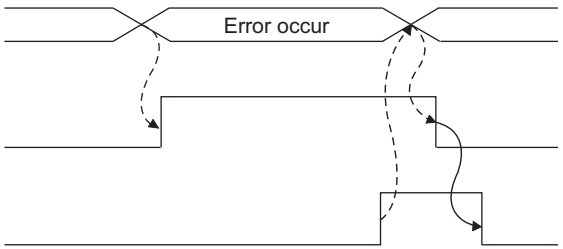
Device No.	Signal name	Description
XB	Channel change completed flag	<p>(1) This is used as an interlock condition for turning on/off Channel change request (YB) when specifying the user range and channel to perform offset/gain settings.</p> <p>(2) Refer to Section 4.6 regarding the offset/gain settings.</p> <p>-----&gt; Performed by the Q66DA-G            —————&gt; Performed by the sequence program</p> <p>Offset/gain setting mode Offset/gain specifications (Un\G22, Un\G23)</p> <p>Offset/gain range setting (Un\G25)</p>  <p>Channel change completed flag (XB)</p> <p>Channel change request (YB)</p> 
		<p>(1) This is used as an interlock condition for turning on/off Set value change request (YC) when adjusting the offset/gain settings.</p> <p>(2) Refer to Section 4.6 regarding the offset and gain settings.</p> <p>-----&gt; Performed by the Q66DA-G            —————&gt; Performed by the sequence program</p> <p>Set value change completed flag (XC)</p> <p>Set value change request (YC)</p> 
XE	Warning output signal	<p>(1) This turns on if the digital input value on any of the channels enabled for D/A conversion rises to or above the Warning output upper limit value or falls below the Warning output lower limit value.</p> <p>(2) Turning on Warning output clear request (YE) or Operating condition setting request (Y9) turns off Warning output signal (XE).</p> <p>-----&gt; Performed by the Q66DA-G            —————&gt; Performed by the sequence program</p> <p>Warning output signal (XE)</p> <p>Warning output clear request (YE)</p> 
		<p>(1) Error flag (XF) turns on when a write error occurs.</p> <p>(2) To turn Error flag (XF) off, remove the cause of the error and turn on Error clear request (YF). Error code (Un\G19) changes to 0 and the ERR. LED turns off.</p> <p>-----&gt; Performed by the Q66DA-G            —————&gt; Performed by the sequence program</p> <p>Error code (Un\G19)</p> <p>Error flag (XF)</p> <p>Error clear request (YF)</p> 

1 OVERVIEW

2 SYSTEM CONFIGURATION

3 SPECIFICATIONS

4 SETUP AND PROCEDURES BEFORE OPERATION

5 UTILITY PACKAGE (GX CONFIGURATOR-DA)

6 PROGRAMMING

7 ONLINE MODULE CHANGE

8 TROUBLESHOOTING

## (2) Output signals

Device No.	Signal name	Description
Y1 to Y6	CH□ Output enable/disable flag	<p>(1) Specify whether to output the D/A converted value or output the offset value for each channel. on: D/A converted value off: Offset value</p> <p>(2) The D/A conversion speed is 6ms X the number conversion-enabled channels regardless of whether the output enable/disable flag is on or off.</p>
Y9	Operating condition setting request	<p>(1) Turn on this signal when changing any of the following settings and making the setting valid.</p> <ul style="list-style-type: none"> <li>- D/A conversion enable/disable setting (Un\G0)</li> <li>- Rate control enable/disable setting (Un\G46)</li> <li>- Warning output setting (Un\G47)</li> <li>- Scaling enable/disable setting (Un\G53)</li> <li>- CH□ Scaling upper/lower limit value (Un\G54 to Un\G65)</li> <li>- CH□ Increase/decrease digital limit value (Un\G70 to Un\G81)</li> <li>- CH□ Warning output upper/lower limit value (Un\G86 to Un\G97)</li> </ul> <p>(2) Refer to the X9 column for the on/off timing.</p>
YA	User range writing request	<p>[In offset/gain setting mode]</p> <p>(1) Turn on this signal when the values for the adjusted offset/gain settings are registered in the Q66DA-G.</p> <p>(2) Refer to the XA column for the on/off timing. Refer to Section 4.6 for offset/gain settings.</p> <p>[In normal mode]</p> <p>(1) Turn on this signal when restoring the user range.</p> <p>(2) Refer to the XA column for the on/off timing. Refer to Chapter 7 for the user range restoration.</p>
YB	Channel change request	<p>(1) Turn on this signal when specifying the user range and channel to perform Offset/gain setting.</p> <p>(2) Refer to the XB column for the on/off timing.</p>
YC	Set value change request	<p>(1) Turn on/off this signal when increasing or decreasing the analog output value during adjustment of the offset/gain settings.</p> <p>(2) The analog output is incremented or decremented depending on the value set to Offset/gain adjustment value specification (Un\G24).</p>
YE	Warning output clear request	<p>(1) Turn on this signal when clearing the warning output.</p> <p>(2) Refer to the XE column for the on/off timing.</p>
YF	Error clear request	<p>(1) Turn on this signal when clearing a write error.</p> <p>(2) Refer to the XF column for the on/off timing.</p>

## ☒ Point

When User range writing request (YA) is turned on with D/A conversion enabled in the normal mode, the Q66DA-G restores the user range.

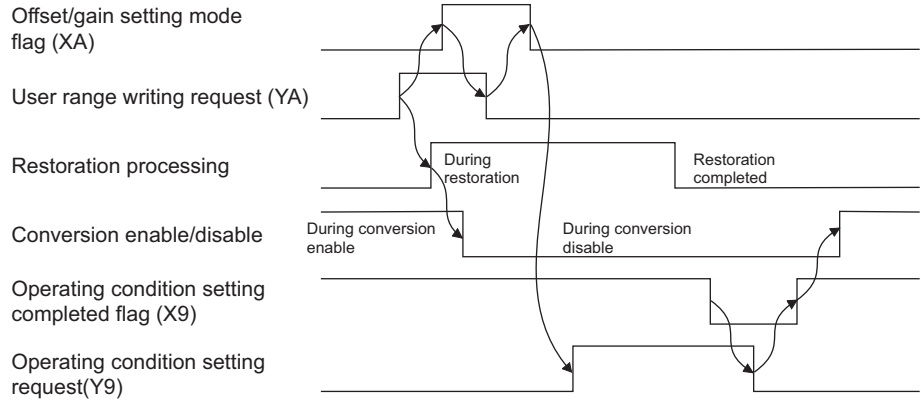

During restoration : D/A conversion disable  
 After restoration : D/A conversion processing can be executed in the restored user range

## 3.4 Buffer Memory

### 3.4.1 Buffer memory assignment

Table3.6 indicates the buffer memory assignment of the Q66DA-G.

#### ☒ Point

Do not write data from system area or sequence program to the buffer memory area where writing is disabled.  
Doing so may cause malfunction.

Table3.6 Buffer memory assignment (1/3)

Address		Description	Default *1	Read/write *2	Reference section
Hexadecimal	Decimal				
0H	0	D/A conversion enable/disable setting	003FH	R/W	Section 3.4.2
1H	1	CH1 Digital value	0	R/W	Section 3.4.3
2H	2	CH2 Digital value	0	R/W	
3H	3	CH3 Digital value	0	R/W	
4H	4	CH4 Digital value	0	R/W	
5H	5	CH5 Digital value	0	R/W	
6H	6	CH6 Digital value	0	R/W	
7H to AH	7 to 10	System area	-	-	-
BH	11	CH1 Set value check code	0	R	Section 3.4.4
CH	12	CH2 Set value check code	0	R	
DH	13	CH3 Set value check code	0	R	
EH	14	CH4 Set value check code	0	R	
FH	15	CH5 Set value check code	0	R	
10H	16	CH6 Set value check code	0	R	
11H	17	System area	-	-	-
12H	18				
13H	19	Error code	0	R	Section 3.4.5
14H	20	Setting range (CH1 to CH4)	0	R	Section 3.4.6
15H	21	Setting range (CH5, CH6)	0	R	
16H	22	Offset/gain setting mode Offset specification	0	R/W	Section 3.4.7
17H	23	Offset/gain setting mode Gain specification	0	R/W	
18H	24	Offset/gain adjustment value specification	0	R/W	Section 3.4.8
19H	25	Offset/gain range setting	0	R/W	Section 3.4.9
1AH to 2DH	26 to 45	System area	-	-	-
2EH	46	Rate control enable/disable setting	003FH	R/W	Section 3.4.10
2FH	47	Warning output setting	003FH	R/W	Section 3.4.11
30H	48	Warning output flag	0	R	Section 3.4.12
31H To 34H	49 to 52	System area	-	-	-

\*1 This is the initial value set after the power is turned on or the programmable controller CPU is reset.

\*2 Indicates whether reading from and writing to a sequence program are enabled.

R : Reading enabled W : Writing enabled



Table 3.6 Buffer memory assignment (2/3)

Address		Description	Default *1	Read/write *2	Reference section
Hexadecimal	Decimal				
35H	53	Scaling enable/disable setting	003FH	R/W	Section 3.4.13
36H	54	CH1 Scaling lower limit value	0	R/W	Section 3.4.14
37H	55	CH1 Scaling upper limit value	0	R/W	
38H	56	CH2 Scaling lower limit value	0	R/W	
39H	57	CH2 Scaling upper limit value	0	R/W	
3AH	58	CH3 Scaling lower limit value	0	R/W	
3BH	59	CH3 Scaling upper limit value	0	R/W	
3CH	60	CH4 Scaling lower limit value	0	R/W	
3DH	61	CH4 Scaling upper limit value	0	R/W	
3EH	62	CH5 Scaling lower limit value	0	R/W	
3FH	63	CH5 Scaling upper limit value	0	R/W	
40H	64	CH6 Scaling lower limit value	0	R/W	
41H	65	CH6 Scaling upper limit value	0	R/W	
42H to 45H	66 to 69	System area	-	-	-
46H	70	CH1 Increase digital limit value	64000	R/W	Section 3.4.15
47H	71	CH1 Decrease digital limit value	64000	R/W	
48H	72	CH2 Increase digital limit value	64000	R/W	
49H	73	CH2 Decrease digital limit value	64000	R/W	
4AH	74	CH3 Increase digital limit value	64000	R/W	
4BH	75	CH3 Decrease digital limit value	64000	R/W	
4CH	76	CH4 Increase digital limit value	64000	R/W	
4DH	77	CH4 Decrease digital limit value	64000	R/W	
4EH	78	CH5 Increase digital limit value	64000	R/W	
4FH	79	CH5 Decrease digital limit value	64000	R/W	
50H	80	CH6 Increase digital limit value	64000	R/W	
51H	81	CH6 Decrease digital limit value	64000	R/W	
52H to 55H	82 to 85	System area	-	-	-
56H	86	CH1 Warning output upper limit value	0	R/W	Section 3.4.16
57H	87	CH1 Warning output lower limit value	0	R/W	
58H	88	CH2 Warning output upper limit value	0	R/W	
59H	89	CH2 Warning output lower limit value	0	R/W	
5AH	90	CH3 Warning output upper limit value	0	R/W	
5BH	91	CH3 Warning output lower limit value	0	R/W	
5CH	92	CH4 Warning output upper limit value	0	R/W	
5DH	93	CH4 Warning output lower limit value	0	R/W	
5EH	94	CH5 Warning output upper limit value	0	R/W	
5FH	95	CH5 Warning output lower limit value	0	R/W	
60H	96	CH6 Warning output upper limit value	0	R/W	
61H	97	CH6 Warning output lower limit value	0	R/W	

\*1 This is the initial value set after the power is turned on or the programmable controller CPU is reset.

\*2 Indicates whether reading from and writing to a sequence program are enabled.

R : Reading enabled W : Writing enabled

Table 3.6 Buffer memory assignment (3/3)

Address		Description	Default <sup>*1</sup>	Read/write <sup>*2</sup>	Reference section
Hexadecimal	Decimal				
62H	98	System area	-	-	-
to	to				
9DH	157				
9EH	158	Mode switching setting	0	R/W	Section 3.4.17
9FH	159		0	R/W	
A0H	160	System area	-	-	-
to	to				
C7H	199				
C8H	200	Pass data classification setting <sup>*3</sup>	0	R/W	Section 3.4.18
C9H	201	System area	-	-	-
CAH	202	CH1 Industrial shipment settings offset value <sup>*3</sup>	0	R/W	Section 3.4.19
CBH	203	CH1 Industrial shipment settings gain value <sup>*3</sup>	0	R/W	
CCH	204	CH2 Industrial shipment settings offset value <sup>*3</sup>	0	R/W	
CDH	205	CH2 Industrial shipment settings gain value <sup>*3</sup>	0	R/W	
CEH	206	CH3 Industrial shipment settings offset value <sup>*3</sup>	0	R/W	
CFH	207	CH3 Industrial shipment settings gain value <sup>*3</sup>	0	R/W	
D0H	208	CH4 Industrial shipment settings offset value <sup>*3</sup>	0	R/W	
D1H	209	CH4 Industrial shipment settings gain value <sup>*3</sup>	0	R/W	
D2H	210	CH5 Industrial shipment settings offset value <sup>*3</sup>	0	R/W	
D3H	211	CH5 Industrial shipment settings gain value <sup>*3</sup>	0	R/W	
D4H	212	CH6 Industrial shipment settings offset value <sup>*3</sup>	0	R/W	
D5H	213	CH6 Industrial shipment settings gain value <sup>*3</sup>	0	R/W	
D6H	214	CH1 User range settings offset value <sup>*3</sup>	0	R/W	
D7H	215	CH1 User range settings gain value <sup>*3</sup>	0	R/W	
D8H	216	CH2 User range settings offset value <sup>*3</sup>	0	R/W	
D9H	217	CH2 User range settings gain value <sup>*3</sup>	0	R/W	
DAH	218	CH3 User range settings offset value <sup>*3</sup>	0	R/W	
DBH	219	CH3 User range settings gain value <sup>*3</sup>	0	R/W	
DCH	220	CH4 User range settings offset value <sup>*3</sup>	0	R/W	
DDH	221	CH4 User range settings gain value <sup>*3</sup>	0	R/W	
DEH	222	CH5 User range settings offset value <sup>*3</sup>	0	R/W	
DFH	223	CH5 User range settings gain value <sup>*3</sup>	0	R/W	
E0H	224	CH6 User range settings offset value <sup>*3</sup>	0	R/W	
E1H	225	CH6 User range settings gain value <sup>*3</sup>	0	R/W	

<sup>\*1</sup> This is the initial value set after the power is turned on or the programmable controller CPU is reset.

<sup>\*2</sup> Indicates whether reading from and writing to a sequence program are enabled.

R : Reading enabled W : Writing enabled

<sup>\*3</sup> Areas used to restore the user range settings offset/gain values when online module change is made.

Refer to Chapter 7 for details of online module change.

## 3.4.2 D/A conversion enable/disable setting (Un\G0)

- (1) Set whether D/A conversion is enabled or disabled for each channel.
- (2) To validate the settings, on/off of Operating condition setting request (Y9) is required. (Refer to Section 3.3.2.)
- (3) By default, all channels are set to D/A conversion disabled.

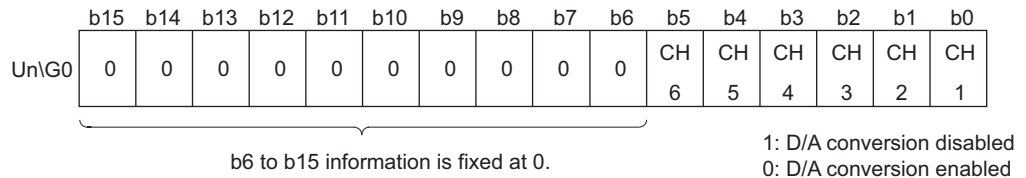

### ☒ Point

Design the system so that D/A conversion enable/disable setting (Un\G0) changes to "Enable" after the external power (Refer to Section 4.3) is supplied. Analog output may not be performed properly if the external power is not at the specified voltage.

## 3.4.3 CH□ Digital value (Un\G1 to Un\G6)

- (1) This area is used to write digital values from the programmable controller CPU as 16-bit signed binary code.
- (2) If a value outside the settable range is written, the upper or lower limit value of the range is used for D/A conversion. (Refer to Table3.7.)  
Also, if this happens, a check code and an error code will be stored in the CH□ Set value check code (Un\G11 to Un\G16) and Error code (Un\G19) respectively.

Table3.7 Output range settings and settable range

Output range setting	Normal resolution mode		High resolution mode	
	Settable range (practical range)	Digital value that is set when a value outside the settable range is written	Settable range (practical range)	Digital value that is set when a value outside the settable range is written
0: 4 to 20 mA	-96 to 4095 (Practical range: 0 to 4000)	4096 or larger: 4095 -97 or smaller: -96	-288 to 12287 (Practical range: 0 to 12000)	12288 or larger: 12287 -289 or smaller: -288
1: 0 to 20 mA				
2: 1 to 5 V				
3: 0 to 5 V	-4096 to 4095 (Practical range: -4000 to 4000)	4096 or larger: 4095 -4097 or smaller: -4096	-16384 to 16383 (Practical range: -16000 to 16000)	16384 or larger: 16383 -16385 or smaller: -16384
4: -10 to 10 V				
A: 4 to 20mA (Extended mode)	-1096 to 4595 (Practical range: -1000 to 4500)	4596 or larger: 4595 -1097 or smaller: -1096	-3288 to 13787 (Practical range: -3000 to 13500)	13788 or larger: 13787 -3289 or smaller: -3288
B: 1 to 5V (Extended mode)				
D: User range setting3	-4096 to 4095 (Practical range: -4000 to 4000)	4096 or larger: 4095 -4097 or smaller: -4096	-12288 to 12287 (Practical range: -12000 to 12000)	12288 or larger: 12287 -12289 or smaller: -12288
E: User range setting2				
F: User range setting1				

## 3.4.4 CH□ Set value check code (Un\G11 to Un\G16)

---

- (1) Digital values set in CH□ Digital value (Un\G1 to Un\G6) are checked and if any of them is outside the settable range, the check result is stored in this area.
- (2) When a digital value outside the settable range (Refer to Table3.7) is written, one of the check codes listed in Table3.8 is stored.

Table3.8 Check code list

Check code	Description
000FH	A digital value exceeding the settable range is written.
00F0H	A digital value that falls short of the settable range is written.
00FFH	A digital value that either falls short or exceeds the settable range was written. For example, the 00FFH check code is stored if a digital value exceeding the valid range is written, and then, without the check code being reset, a digital value that falls short of the settable range is written.

- (3) Once a check code is stored, it will not be reset even if the digital value is within the settable range.
- (4) To reset CH□ Set value check code, set Error clear request (YF) to on after rewriting the digital value so that it is within the settable range.
- (5) When the scaling function is used, digital values converted from the digital values set in CH□ Digital value (Un\G1 to Un\G6) are checked. (Refer to Section 3.2.5.)

## 3.4.5 Error code (Un\G19)

---

- (1) This area stores the error codes detected by the Q66DA-G.
- (2) Refer to Section 8.1 for more details of the error codes.

## 3.4.6 Setting range (Un\G20, Un\G21)

(1) This area is used to confirm the setting range of the Q66DA-G.

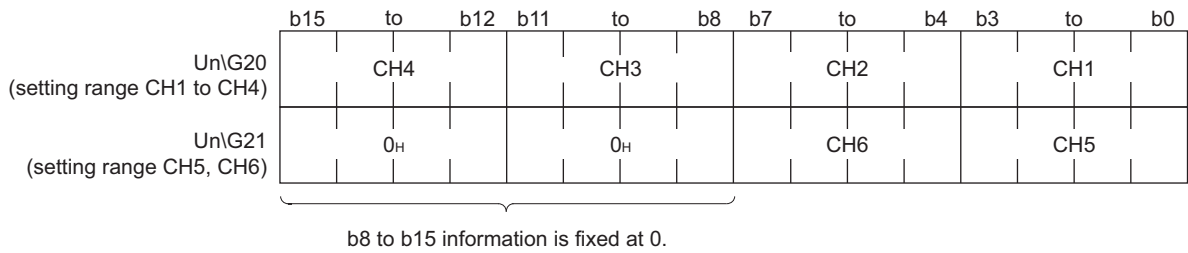

Output range	Storing value
4 to 20mA	0 <sub>H</sub>
0 to 20mA	1 <sub>H</sub>
1 to 5V	2 <sub>H</sub>
0 to 5V	3 <sub>H</sub>
-10 to 10V	4 <sub>H</sub>
4 to 20mA (Extended mode)	A <sub>H</sub>
1 to 5V (Extended mode)	B <sub>H</sub>
User range setting 3	D <sub>H</sub>
User range setting 2	E <sub>H</sub>
User range setting 1	F <sub>H</sub>

### ☒ Point

The output range cannot be changed by using Setting range (Un\G20, Un\G21). Change the output range in the switch setting for I/O and intelligent function module dialog box. (Refer to Section 4.5)

## 3.4.7 Offset/gain setting mode Offset/gain specification (Un\G22, Un\G23)

- (1) Specifies the channel to be adjusted for the offset/gain settings.
- (2) Channel change request (YB) must be turned on/off to validate the offset/gain setting. (Refer to Section 3.3.2.)
- (3) Specification can be made for 1 channel only.  
If more than one channel is set at the same time, an error occurs and an error code is stored in Error code (Un\G19).
- (4) Refer to Section 4.6 for the details of the offset/gain settings.

	b15	b14	b13	b12	b11	b10	b9	b8	b7	b6	b5	b4	b3	b2	b1	b0
Un\G22 (Offset specification)	0	0	0	0	0	0	0	0	0	0	CH	CH	CH	CH	CH	CH
Un\G23 (gain specification)	0	0	0	0	0	0	0	0	0	0	CH	CH	CH	CH	CH	CH

b6 to b15 information is fixed at 0.

1: Channel to be set  
0: Invalid

## 3.4.8 Offset/gain adjustment value specification (Un\G24)

- (1) This area is used to set the amount of adjustment for analog output values in the offset/gain setting mode.
- (2) Turning Set value change request (YC) from off to on increments or decrements the analog output value by the adjustment value.
- (3) The settable input range is from -3000 to 3000.  
When the set value is 1000, the analog output values can be adjusted by following value.

Output range	Adjustment when set value is 1000
User range setting1	Approx. 0.86mA
User range setting2	Approx. 0.38V
User range setting3	Approx. 0.19V

- (4) Refer to Section 4.6 for details of offset/gain setting.

## 3.4.9 Offset/gain range setting (Un\G25)

- (1) This area is used to change the output range in the offset/gain setting mode. Turning on Channel change request (YB) changes the output range into the set one. If any value outside the setting range is set, an error occurs and the corresponding Error code (Un\G19) is stored.

Output range	Set value
User range setting 1	000FH
User range setting 2	000EH
User range setting 3	000DH

- (2) Channel change request (YB) must be turned on/off to validate the offset/gain range setting. (Refer to Section 3.3.2.)
- (3) Refer to Section 4.6 for details of offset/gain setting.

## 3.4.10 Rate control enable/disable setting (Un\G46)

- (1) Set whether to enable or disable the rate control on each channel.
- (2) To validate the settings, on/off of Operating condition setting request (Y9) is required. (Refer to Section 3.3.2.)
- (3) The default setting is all-channel rate control disable.

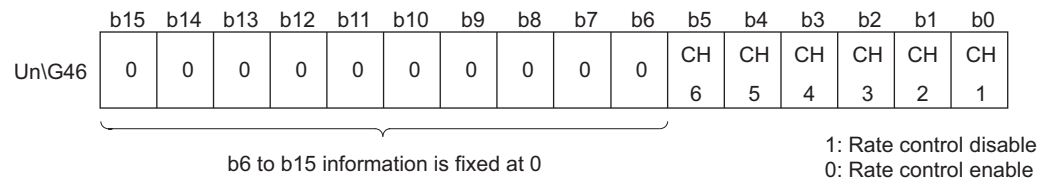

- (4) Refer to Section 3.2.4 for details of rate control function.

## 3.4.11 Warning output setting (Un\G47)

- (1) Set whether to enable or disable the warning output on each channel.
- (2) To validate the settings, on/off of Operating condition setting request (Y9) is required. (Refer to Section 3.3.2.)
- (3) The default setting is all-channel warning output disable.

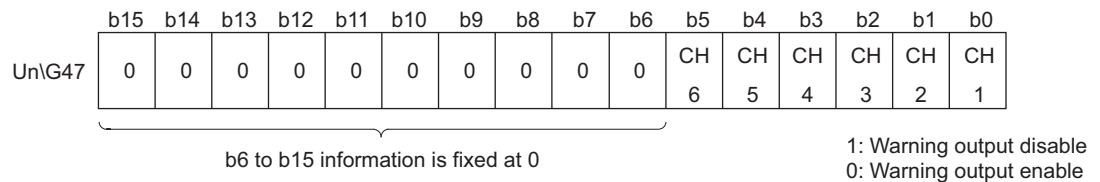

- (4) Refer to Section 3.2.3 for details of warning output function.

## 3.4.12 Warning output flag (Un\G48)

- (1) When the digital input value falls outside CH□ Warning output upper/lower limit value (Un\G86 to Un\G97) range, the bit corresponding to each channel turns to "1".
- (2) Whether the warning is the upper or lower limit value warning can be checked on each channel.
- (3) If the warning is detected on any of the channels enabled for conversion, Warning output signal (XE) turns on.
- (4) Turning on Operating condition setting request (Y9) or Warning output clear request (YE) clears Warning output flag.

	b15	b14	b13	b12	b11	b10	b9	b8	b7	b6	b5	b4	b3	b2	b1	b0
Un\G48	0	0	0	0	CH6 lower limit value	CH6 upper limit value	CH5 lower limit value	CH5 upper limit value	CH4 lower limit value	CH4 upper limit value	CH3 lower limit value	CH3 upper limit value	CH2 lower limit value	CH2 upper limit value	CH1 lower limit value	CH1 upper limit value

b12 to b15 information is fixed at 0

1: Warning output  
0: Normal

- (5) Refer to Section 3.2.3 for details of warning output function.

## 3.4.13 CH□ Scaling enable/disable setting (Un\G53)

- (1) Set whether to enable or disable the scaling on each channel.
- (2) To validate the settings, on/off of Operating condition setting request (Y9) is required. (Refer to Section 3.3.2.)
- (3) The default setting is all-channel scaling disable.

	b15	b14	b13	b12	b11	b10	b9	b8	b7	b6	b5	b4	b3	b2	b1	b0
Un\G53	0	0	0	0	0	0	0	0	0	0	CH 6	CH 5	CH 4	CH 3	CH 2	CH 1

b6 to b15 information is fixed at 0

1: Scaling disable  
0: Scaling enable

- (4) Refer to Section 3.2.5 for details of warning output function.



## 3.4.14 CH□ Scaling upper/lower limit value (Un\G54 to Un\G65)

- (1) When the scaling function is used, set a digital value input range. (Refer to Section 3.2.5.)
- (2) The setting range is -32000 to 32000.  
Set them so that the scaling upper limit value is greater than the scaling lower limit value.  
If any value outside the setting range is set, an error occurs and the corresponding Error code (Un\G19) is stored.
- (3) To validate the settings, on/off of Operating condition setting request (Y9) is required. (Refer to Section 3.3.2.)

## 3.4.15 CH□ Increase/decrease digital limit value (Un\G70 to Un\G81)

- (1) For rate control, set the range where the digital value can be incremented and decremented in a conversion cycle per channel (6ms). (Refer to Section 3.2.4.)
- (2) The setting range is 0 to 64000 (0H to FA00H).  
If any value outside the setting range is set, an error occurs and the corresponding error code is stored in Error code (Un\G19).
- (3) Operating condition setting request (Y9) must be turned on/off to validate the settings. (Refer to Section 3.3.2.)

### ☒ Point

When setting CH□ Increase/decrease digital limit value (Un\G70 to Un\G81) from the sequence program, values from 0 to 32767 can be set as decimal numbers without change. Note that this is not applicable to 32768 to 65535. These values must be converted to hexadecimal numbers before setting.

## 3.4.16 CH□ Warning output upper/lower limit value (Un\G86 to Un\G97)

- (1) Set the upper and lower limit values of the digital input value for providing the warning output. (Refer to Section 3.2.3.)
- (2) The setting range is -32000 to 32000.  
Make setting so that the upper limit value is greater than the lower limit value.  
If any value outside the setting range is set, an error occurs and the corresponding error code (Un\G19) is stored.
- (3) Operating condition setting request (Y9) must be turned on/off to validate the settings. (Refer to Section 3.3.2.)

## 3.4.17 Mode switching setting (Un\G158, Un\G159)

- (1) Set the values of the mode to switch.
- (2) After setting the values, turning Operation condition setting request (Y9) from off to on enables mode switching.
- (3) When mode switching is performed, this area is cleared to zero and Operating condition setting completed flag (X9) turns off.  
After confirming that Operating condition setting completed flag (X9) has turned off, turn off Operating condition setting request (Y9).

Mode to be switched to	Set values	
	Buffer memory address 158	Buffer memory address 159
Normal mode	0964H	4144H
Offset/gain setting mode	4144H	0964H

### ☒ Point

If the values written are other than the above, mode switching is not performed and only the operating condition is changed.

## 3.4.18 Pass data classification setting (Un\G200)

- (1) Areas used to restore the user range settings offset/gain values when online module change is made.  
Refer to Chapter 7 for details of online module change.
- (2) Specify the user range setting to be saved/restored when saving/restoring the offset/gain values of any of the user range settings 1 to 3.

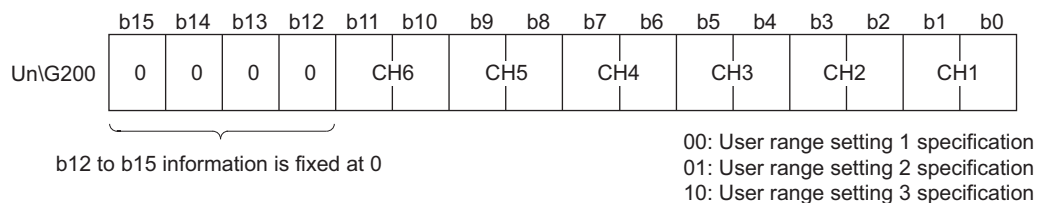

### ☒ Point

Refer to Section 4.6 for the offset/gain value setting method.

## 3.4.19 Industrial shipment settings and user range settings offset/gain values (Un\G202 to Un\G225)

- (1) Areas used to restore the user range settings offset/gain values when online module change is made.  
Refer to Chapter 7 for details of online module change.
- (2) When the offset/gain values of the user range setting are restored, the data to be used are stored (saved) when:
  - Initial setting is written by the utility;
  - The operating condition is set (Y9 turns from off to on\*1);
  - The offset/gain values are written in the offset/gain setting mode (YA turns from off to on).

\*1 The data are not saved when the set values have been written to Mode switch setting (Un\G158, Un\G159).
- (3) When restoring the offset/gain values of the user range setting, set the data saved in this area similarly into the corresponding area of the module where the data will be restored.
- (4) Buffer memory saving record procedure for online module change
  - 1) Set Pass data classification setting (Un\G200).
  - 2) Turn Operating condition setting request (Y9) from off to on.
  - 3) Compare the offset/gain values of CH□ Industrial shipment and User range settings (Un\G202 to Un\G217) with the range reference table. Refer to Section 7.4 for the range reference table.
  - 4) If the values are proper, record the data in Pass data classification setting, Industrial shipment settings, and User range settings.

### ☒ Point

Refer to Section 4.6 for the offset/gain value setting method.

1

OVERVIEW

2

SYSTEM CONFIGURATION

3

SPECIFICATIONS

4

SETUP AND PROCEDURES BEFORE OPERATION

5

UTILITY PACKAGE (GX CONFIGURATOR-DA)

6

PROGRAMMING

7

ONLINE MODULE CHANGE

8

TROUBLESHOOTING

## 4 SETUP AND PROCEDURES BEFORE OPERATION

### 4.1 Handling Precautions

- (1) Do not drop the module case or subject it to heavy impact.
- (2) Do not remove the PCB of the module from its case. Doing so may cause the module failure.
- (3) Be careful not to let foreign materials such as swarf or wire chips enter the module. They may cause a fire, mechanical failure or malfunction.
- (4) The top surface of the module is covered with a protective film to prevent foreign materials such as wire chips from entering the module during wiring. Do not remove this film until the wiring is completed. Before operating the system, be sure to remove the film to provide adequate heat radiation.
- (5) Before handling the module, touch a grounded metal object to discharge the static electricity from the human body. Failure to do so may cause the module to fail or malfunction.
- (6) Tighten the screws such as module fixing screws within the following ranges. Loose screws may cause short circuits, failures or malfunctions.

Screw location	Tightening torque range
Module fixing screw (M3 screw) <sup>*1</sup>	0.36 to 0.48 N·m
Connector screw (M2.6 screw)	0.20 to 0.29 N·m
FG Terminal screw (M3 screw)	0.42 to 0.58 N·m

\*1: The module can be easily fixed onto the base unit using the hook at the top of the module. However, it is recommended to secure the module with the module fixing screw if the module is subject to significant vibration.

- (7) To mount the module, while pressing the module mounting lever located in the lower part of the module, fully insert the module fixing projection(s) into the hole(s) in the base unit until it stops. Improper mounting may result in malfunction, breakdown or the module coming loose and dropping.

- (8) Fix the Q66DA-G with module fixing bracket after the Q66DA-G is mounted to the base unit.

## ☒ Point

Make sure that the hook at the tip of the module fixing bracket is hooked on the 3rd slit viewed from the front of Q66DA-G.

Tighten the module fixing screw by the specified torque.

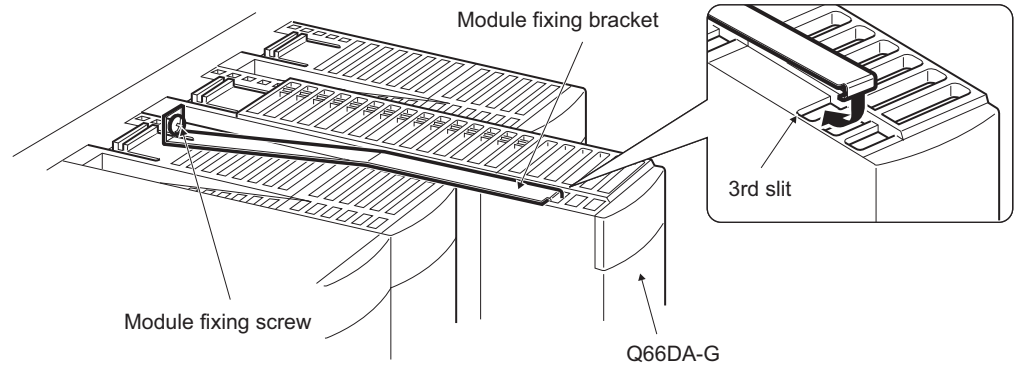

## 4.2 Setup and Procedures Before Operation

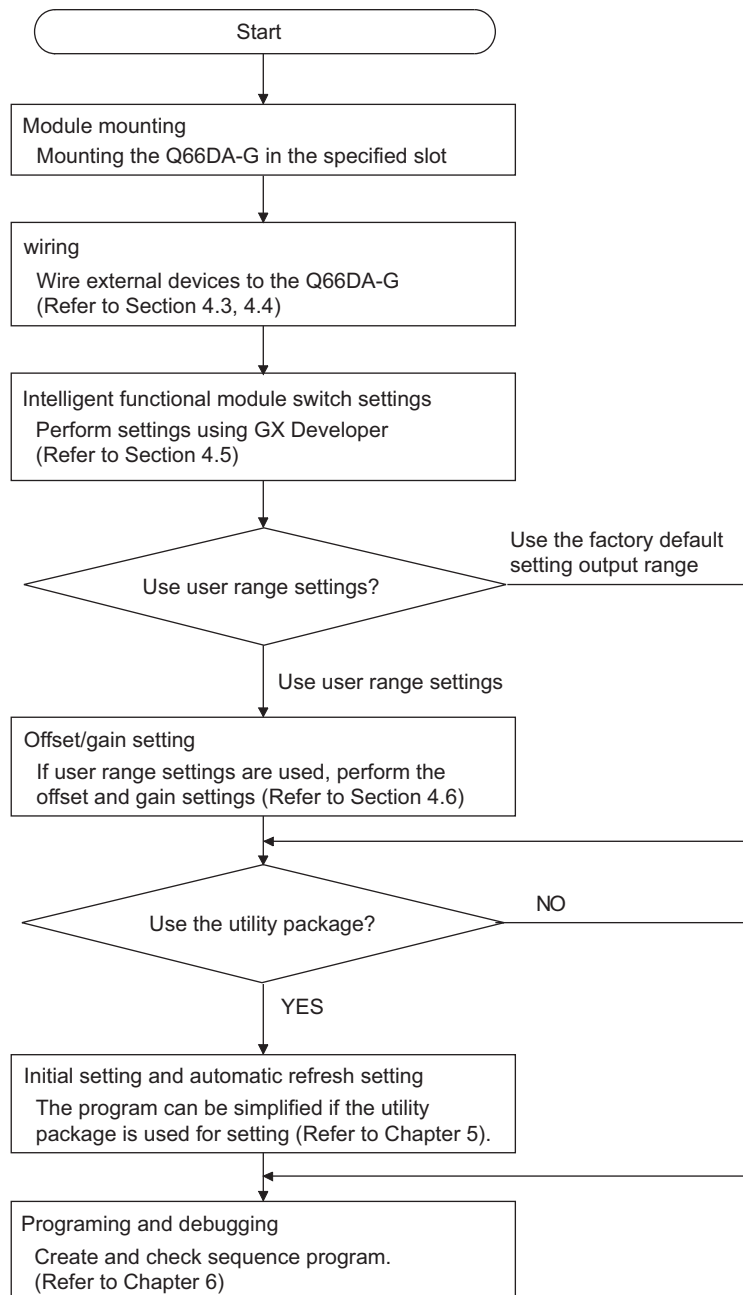

## 4.3 Part Names

Parts of the Q66DA-G are listed below.

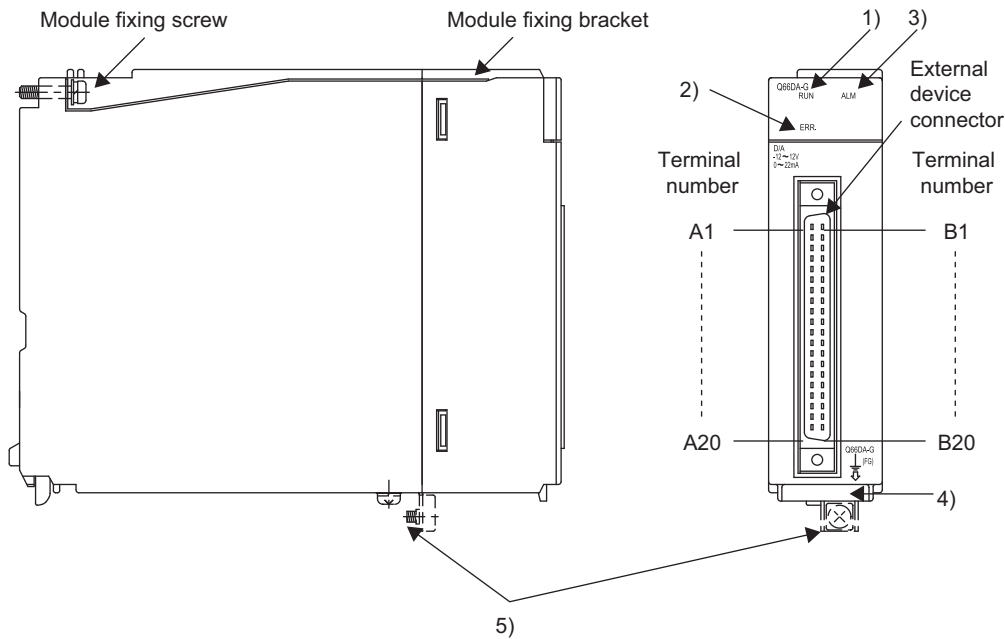

Number	Name	Description
1)	RUN LED <sup>*1</sup>	Displays the operating status of the Q66DA-G. On : Normal operation Flashing : During offset/gain setting mode Off : 5V power switched off, watchdog timer error occurred, or online module change enabled.
2)	ERR. LED	Displays the error status of the Q66DA-G. On : Error (Refer to Section 8.1) Flashing : Error in switch settings Switch No. 5 of the intelligent function module has been set to a value other than zero "0". Off : Normal operation
3)	ALM LED	Indicates the warning status of the Q66DA-G. On : During warning output occurrence (Refer to Section 3.2.3) Off : Normal operation
4)	Serial number plate	Indicates the serial No. of the Q66DA-G.
5)	FG terminal L-Shaped metal fitting	Metal fitting to wire for FG of the Q66DA-G.

\*1: When the module is mounted on a MELSECNET/H remote I/O station, the RUN LED stays off until a data link starts normally, even after the power is turned on.

### ☒ Point

When two or more errors have occurred, these LEDs indicate the latest error found by the Q66DA-G.

# 4 SETUP AND PROCEDURES BEFORE OPERATION

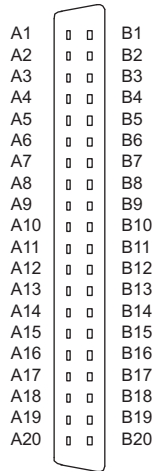

Seen from the front of the module

Terminal number	Signal name	Terminal number	Signal name
A1	CH1 V +	B1	CH1 COM
A2	CH1 I +	B2	-
A3	-	B3	-
A4	CH2 V +	B4	CH2 COM
A5	CH2 I +	B5	-
A6	-	B6	-
A7	CH3 V +	B7	CH3 COM
A8	CH3 I +	B8	-
A9	-	B9	-
A10	CH4 V +	B10	CH4 COM
A11	CH4 I +	B11	-
A12	-	B12	-
A13	CH5 V +	B13	CH5 COM
A14	CH5 I +	B14	-
A15	-	B15	-
A16	CH6 V +	B16	CH6 COM
A17	CH6 I +	B17	-
A18	-	B18	-
A19	24VDC	B19	24VDC
A20	24GDC	B20	24GDC

## (1) Connector for external wiring

The connectors for use with the Q66DA-G should be purchased separately by the user. The following tables show the connector types and the crimp-contact tool.

### (a) Connector types\*<sup>1</sup>

Type	Model name	Applicable wire size
Soldering type (straight out)	A6CON1	0.3mm <sup>2</sup> (22 AWG) (stranded)
Crimp-contact type (straight out)	A6CON2	0.088 to 0.24mm <sup>2</sup> (28 to 24 AWG) (stranded)
Soldering type (straight out/diagonal out)	A6CON4	0.3mm <sup>2</sup> (22 AWG) (stranded)

\*1The A6CON3 (pressure-displacement type, straight out) connector cannot be used for the Q66DA-G.

### (b) Crimp-contact tool

Type	Model name	Applicable wire size	Contact
Crimp-contact tool	FCN-363T-T005/H	0.088 to 0.24mm <sup>2</sup> (28 to 24 AWG)	FUJITSU COMPONENT LIMITED <a href="http://www.fcl.fujitsu.com/en">www.fcl.fujitsu.com/en</a>



## 4.4 Wiring

The wiring precautions and examples of module connection are provided below.

### 4.4.1 Wiring precautions

In order to optimize the functions of the Q66DA-G and ensure system reliability, external wiring that is protected from noise is required.

The following shows the precautions for external wiring.

- (1) Use separate cables for the alternating-current control circuit and the external output signals and external supply power of the Q66DA-G in order to avoid AC surges and induction effects.
- (2) Do not mount the cables close to or bundle them with the main circuit line, a high-voltage cable or a load cable from other than the programmable controller. This may increase the effects of noise, surges and induction.
- (3) Perform a one-point grounding for shielded lines and the shields of shielded cables.
- (4) When the wiring of the module mounted right to the Q66DA-G is difficult, perform wiring after removing the Q66DA-G.

## 4.4.2 External wiring

### (1) For voltage output

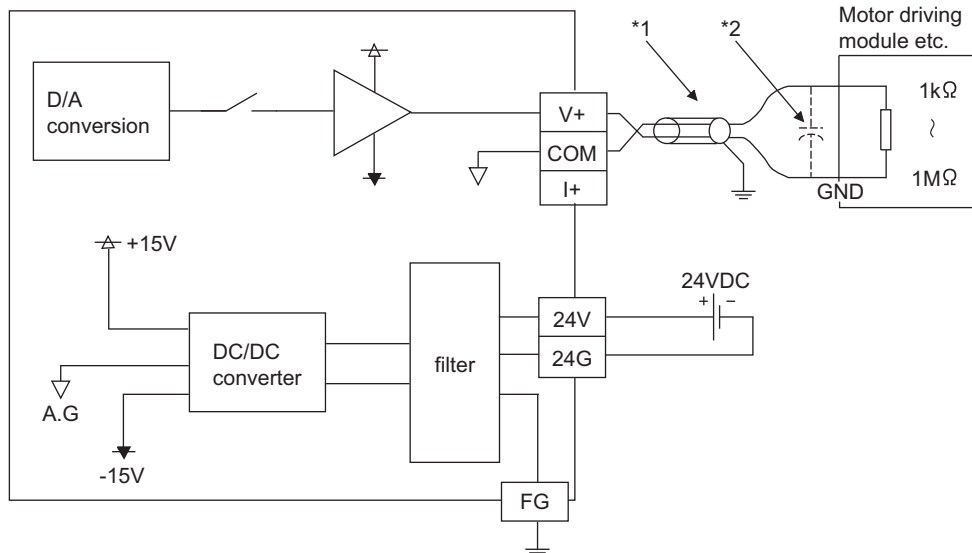

\*1 For wire, use the shielded twisted pair cable.

\*2 If noise or ripple occurs for external wiring, connect a capacitor with the value of 0.1 to 0.47  $\mu$ F (with-stand voltage 25V or higher) to the input terminal of an external device.

### (2) For current output

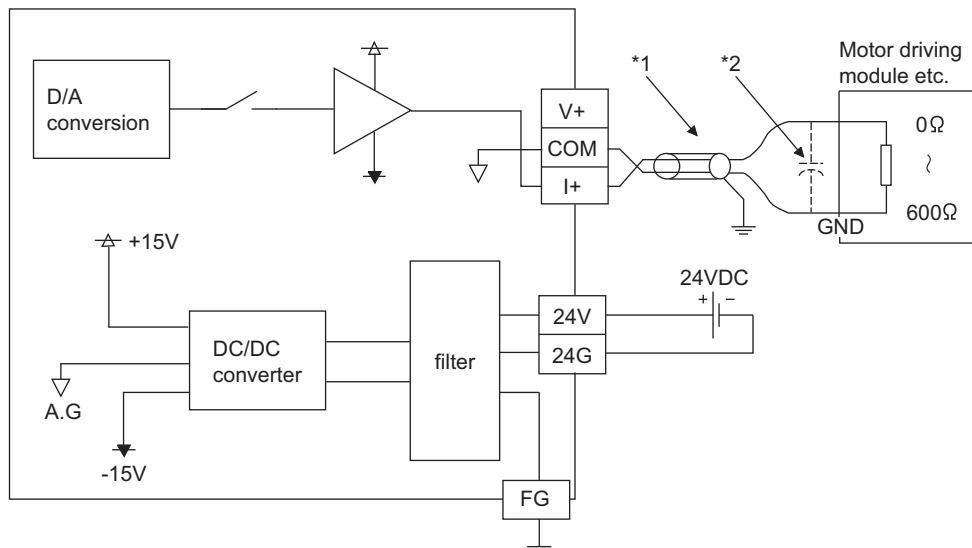

\*1 For wire, use the shielded twisted pair cable.

\*2 If noise or ripple occurs for external wiring, connect a capacitor with the value of 0.1 to 0.47  $\mu$ F (with-stand voltage 25V or higher) to the input terminal of an external device.

### ☒ Point

The Q66DA-G needs to be powered on 30 minutes prior to operation for compliance to the specification (accuracy).

Similarly, power on 30 minutes prior to offset/gain setting or after online module replacement.

## 4.4.3 Connector/terminal block converter module

For the following products, please consult your local Mitsubishi Electric sales office or representative.

Product	Model	Manufacturer
Dedicated cable	FA-CBL□□Q66DAG*1	Mitsubishi Electric Engineering Co., Ltd.
Connector/terminal block converter module	FA1-TBS40DAG	
	FA-LTB40DAG	

\*1 □□ shows the cable length (05: 0.5m, 10: 1.0m, 20: 2.0m, 30: 3.0m).

### ⊠ Point

The offset/gain setting is adjusted in the Q66DA-G at the industrial shipment setting of the module.

Therefore an error may occur for the conversion characteristic because of the influence such as the conductor resistance when a dedicated cable or connector/terminal block converter module is used.

If a problem occurs by the influence, perform the offset/gain setting by using the user range setting. (Refer to Section 4.6.)

## 4.5 Intelligent Function Module Switch Setting

The intelligent function module switches are set in the I/O assignment setting of GX Developer.

### (1) Setting items

The intelligent function module switches, 1 to 5, are set using 16 bit data. The default value for switches 1 to 5 is 0.

Table4.1 Switch setting item for intelligent function module

		Setting item																							
Switch 1	Output range setting(CH1to CH4) 	<table border="1"> <thead> <tr> <th>Analog output range</th> <th>Output range setting value</th> </tr> </thead> <tbody> <tr> <td>4 to 20 mA</td> <td>0H</td> </tr> <tr> <td>0 to 20 mA</td> <td>1H</td> </tr> <tr> <td>1 to 5 V</td> <td>2H</td> </tr> <tr> <td>0 to 5 V</td> <td>3H</td> </tr> <tr> <td>-10 to 10 V</td> <td>4H</td> </tr> <tr> <td>4 to 20mA (Extended mode)</td> <td>AH</td> </tr> <tr> <td>1 to 5V (Extended mode)</td> <td>BH</td> </tr> <tr> <td>User range setting3</td> <td>DH</td> </tr> <tr> <td>User range setting2</td> <td>EH</td> </tr> <tr> <td>User range setting1</td> <td>FH</td> </tr> </tbody> </table>	Analog output range	Output range setting value	4 to 20 mA	0H	0 to 20 mA	1H	1 to 5 V	2H	0 to 5 V	3H	-10 to 10 V	4H	4 to 20mA (Extended mode)	AH	1 to 5V (Extended mode)	BH	User range setting3	DH	User range setting2	EH	User range setting1	FH	
	Analog output range		Output range setting value																						
4 to 20 mA	0H																								
0 to 20 mA	1H																								
1 to 5 V	2H																								
0 to 5 V	3H																								
-10 to 10 V	4H																								
4 to 20mA (Extended mode)	AH																								
1 to 5V (Extended mode)	BH																								
User range setting3	DH																								
User range setting2	EH																								
User range setting1	FH																								
Switch 2	Output range setting (CH5, CH6) 																								
Switch 3		HOLD/CLEAR function setting 0: CLEAR 1: HOLD																							
Switch 4																									
Switch 5	0H: Fixed																								

\*1 Setting any value within the setting range provides the same operation.  
When the setting range is 1H to FH, set 1H for example.

## ☒ Point

- (1) The switch 3 is set in binary.  
Setting will be easy if the input format is changed to binary number.

[Example For setting CH3, CH5 and CH6 to HOLD.]

Input format	Binary	Hexadecimal
Setting value	00110100	34H

- (2) If the offset/gain setting mode is set using intelligent function module switch 4, resolution mode will be ignored.
- (3) Perform the offset/gain settings after checking the RUN LED flashes in offset/gain setting mode. If the RUN LED does not flash, check if the switch 4 setting is correct.
- (4) Since the analog output value differs considerably depending on the resolution mode setting, thoroughly check the settings for the intelligent function module switches before performing the analog output processing.  
[Example Analog output value when the setting range is -10 to 10V and the digital input value is set to 4000.]

	High resolution mode	Normal resolution mode
Analog output value	About 2.5 V	About 10.0 V

## (2) Operating procedure

Start the configuration from GX Developer's I/O assignment setting screen.

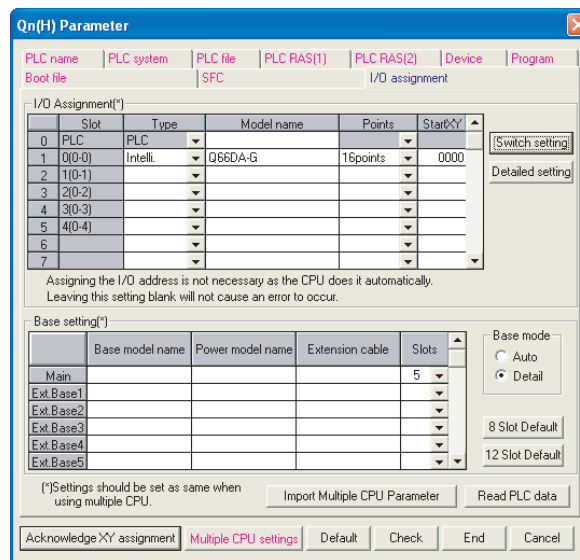

(a) I/O assignment setting screen

Set the following for the slot in which the Q66DA-G is mounted.

The type setting is required; set other items as needed.

Type :Select "intelli."

Model name :Enter the module model name.

Points :Select 16 points.

Start XY :Enter the start I/O signal for the Q66DA-G.

Detailed setting :

- 1) When using in the standard system configuration (on the main or extension base), specify the control CPU of the Q66DA-G.

The analog output status of when an error has occurred in the Q66DA-G is determined according to the setting of "HOLD/CLEAR function setting" of the switch setting for intelligent function module. Therefore, the setting of "Error time output mode" is invalid.

- 2) When using on a remote I/O station, if the analog output is to be held in the case of a link error, "Error time output mode" must be set to "Hold".

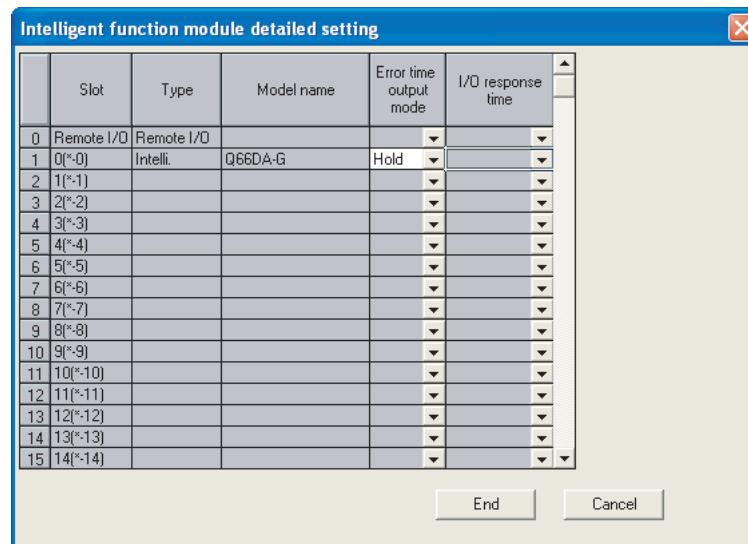

3) Switch setting for intelligent function module dialog box

Click on [Switch setting] on the I/O assignment setting dialog box to display the dialog box shown below, then set switches 1 to 5.

The switches can easily be set if values are entered in hexadecimal. Change the entry format to hexadecimal and then enter the values.

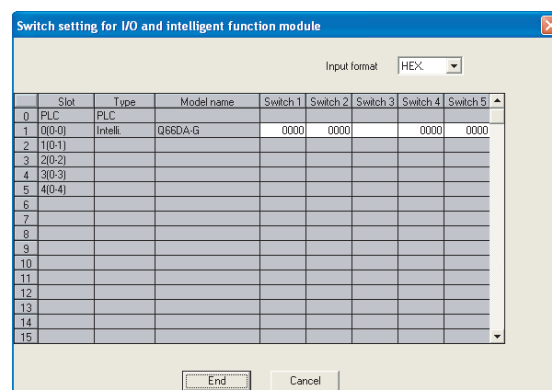

## 4.6 Offset/Gain Settings

When the user range setting is used, perform the offset and gain settings according to the following procedure.

When the industrial shipment setting is used, offset/gain setting is not necessary.

If the utility package is installed, perform the offset/gain settings according to the procedure described in Section 5.6.2.

### (1) Offset/gain setting procedure

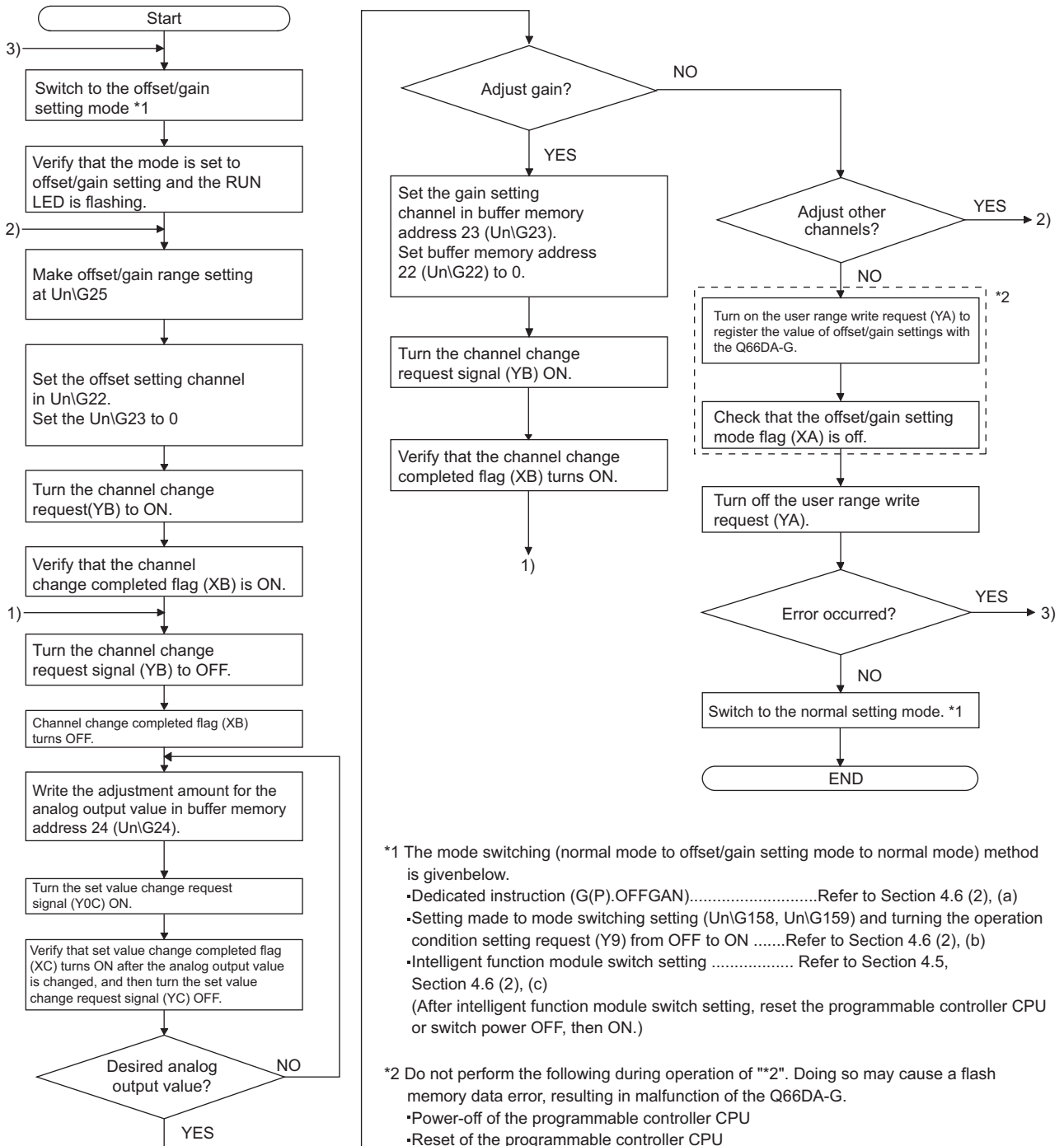

\*1 The mode switching (normal mode to offset/gain setting mode to normal mode) method is given below.  
 •Dedicated instruction (G(P).OFFGAN).....Refer to Section 4.6 (2), (a)  
 •Setting made to mode switching setting (Un\G158, Un\G159) and turning the operation condition setting request (Y9) from OFF to ON .....Refer to Section 4.6 (2), (b)  
 •Intelligent function module switch setting ..... Refer to Section 4.5, Section 4.6 (2), (c)  
 (After intelligent function module switch setting, reset the programmable controller CPU or switch power OFF, then ON.)

\*2 Do not perform the following during operation of "\*\*2". Doing so may cause a flash memory data error, resulting in malfunction of the Q66DA-G.  
 •Power-off of the programmable controller CPU  
 •Reset of the programmable controller CPU

## ☒ Point

---

- (1) Set the offset/gain values in the range that satisfies the conditions specified in Section 3.1.2, (1) and (2).  
When the setting exceeds this range, the maximum resolution or total accuracy may not be within the range indicated in the performance specification.
  - (2) Set the offset/gain values separately for each channel. If channels are set in Un\G22 and Un\G23 at the same time, an error will occur and the ERR. LED will be lit.
  - (3) After the offset and gain settings are completed, verify that the offset and gain values have been set correctly under actual usage conditions.
  - (4) The offset and gain values are stored into the flash memory and are not erased at power-off.
  - (5) At the time of offset/gain setting, turn on User range writing request (YA) to write the values to the flash memory.  
Data can be written to the flash memory up to 100 thousand times.  
To prevent unnecessary write to the flash memory, an error (Error code: 162) occurs when data are written 26 times continuously.
  - (6) If an error (Error code: 40□\*<sup>1</sup>) occurs during offset/gain setting, re-set the correct offset/gain value.  
The offset/gain value of the channel where the error has occurred is not written to the Q66DA-G. (\*1 indicates the corresponding channel number.)
  - (7) Module READY (X0) turns from off to on when the offset/gain setting mode switches to the normal mode by the dedicated instruction (G(P).OFFGAN) or the setting of Mode switching setting (Un\G158, Un\G159).  
Note that initial setting processing will be executed if there is a sequence program that makes initial setting when Module READY (X0) turns on.
  - (8) D/A conversion is discontinued if the mode is switched (from the normal mode to the offset/gain setting mode or from the offset/gain setting mode to the normal mode) by the dedicated instruction (G(P).OFFGAN) or the setting of Mode switching setting (Un\G158, Un\G159).
  - (9) Un\G200, Un\G202 to Un\G217 are the areas used to restore the user range settings offset/gain values when online module change is made.  
Refer to Chapter 7 for details of online module change.
-



## (2) Program examples

The program in the dotted area of (a) is common to (a), (b) and (c).  
 In this example, the I/O signals for the Q66DA-G are X/Y0 to X/YF.

- Channel selection..... M0
- Offset/gain range setting..... M1
- Offset setting ..... M2
- Gain setting ..... M3
- Channel change command ..... M4
- Writing the adjustment amount ..... M5
- Analog output value adjust command ..... M6
- Offset/gain setting value write command to the module ..... M7
- Mode switching..... M8
- Normal mode checking signal..... M50
- Channel designation storage device..... D0
- Dedicated instruction (G(P).OFFGAN) setting storage device..... D2
- Offset/gain adjustment storage device..... D1

1	OVERVIEW
2	SYSTEM CONFIGURATION
3	SPECIFICATIONS
4	SETUP AND PROCEDURES BEFORE OPERATION
5	UTILITY PACKAGE (GX CONFIGURATOR-DA)
6	PROGRAMMING
7	ONLINE MODULE CHANGE
8	TROUBLESHOOTING

# 4 SETUP AND PROCEDURES BEFORE OPERATION

- (a) When switching the mode using the dedicated instruction (G(P).OFFGAN)  
 The following sample program switches to the offset/gain setting mode with the dedicated instruction (G(P).OFFGAN), changes the channel where offset/gain setting will be made, adjusts the offset/gain values, and writes the offset/gain values to the Q66DA-G.

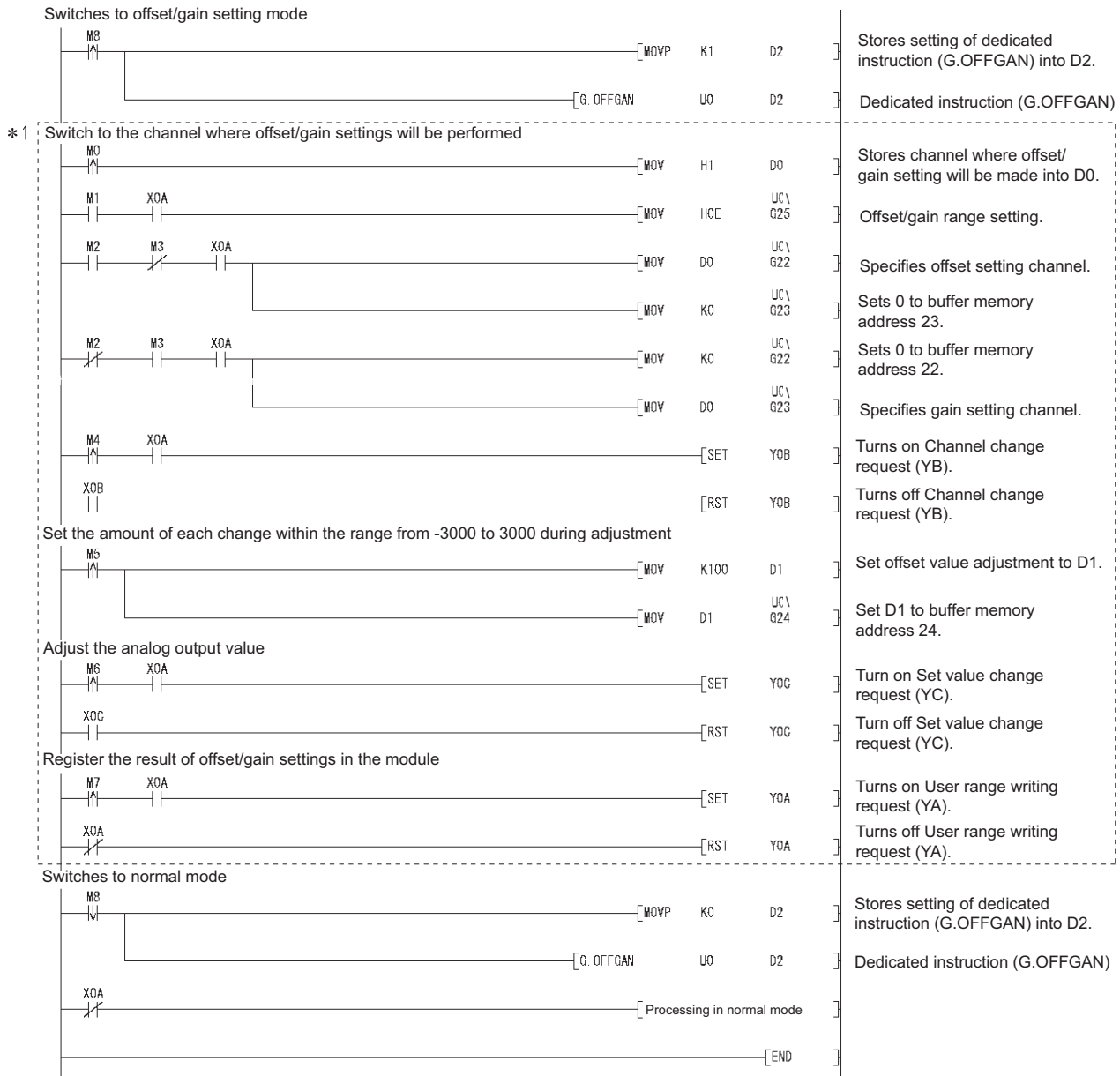

\* 1 The program in the dotted area is a common program.

# 4 SETUP AND PROCEDURES BEFORE OPERATION

(b) When switching the mode using the setting of Mode switching setting (Un\G158, Un\G159) and Operating condition setting request (Y9)

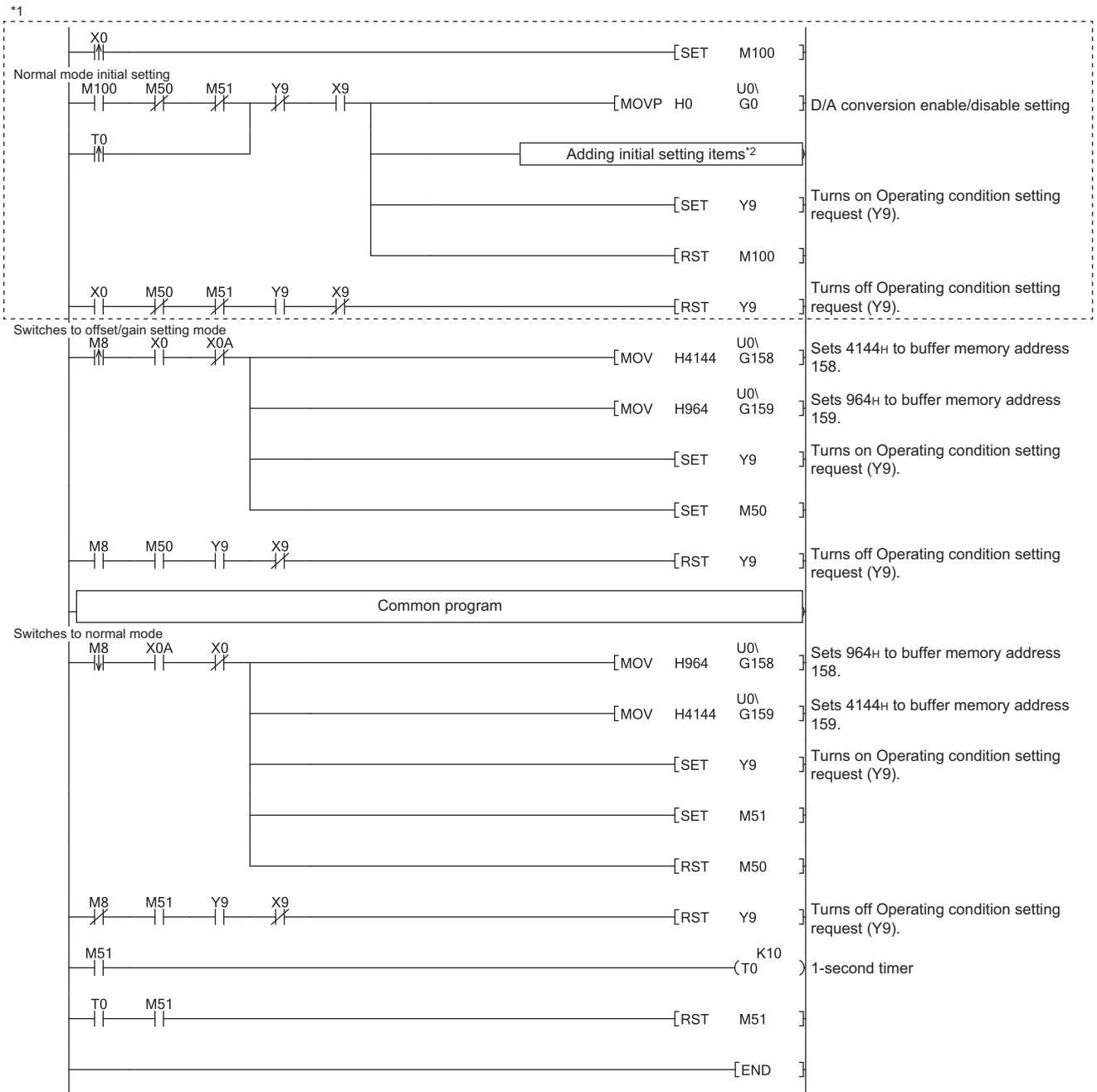

1 OVERVIEW

2 SYSTEM CONFIGURATION

3 SPECIFICATIONS

4 SETUP AND PROCEDURES BEFORE OPERATION

5 UTILITY PACKAGE (GX CONFIGURATOR-DA)

6 PROGRAMMING

7 ONLINE MODULE CHANGE

8 TROUBLESHOOTING

## ☒ Point

When running this program together with the normal-mode D/A conversion program (Refer to Section 6.2.3), use <sup>\*1</sup> of this program as the initial setting program. To utilize each function of the Q66DA-G for D/A conversion in normal mode, add an appropriate initial setting item to the part marked <sup>\*2</sup>. (Refer to an example below.)

<sup>\*2</sup> Example of adding initial setting items (Rate control function)

[	MOV	H3E	U0\ G46	]	Rate control enable/disable setting
[	MOV	K100	U0\ G70	]	CH1 Increase digital limit value
[	MOV	K30	U0\ G71	]	CH1 Decrease digital limit value

Note) When adding this program to the normal-mode D/A conversion program (Refer to Section 6.2.3), replace the existing initial setting program with the program marked <sup>\*1</sup>.

- (c) When switching the mode by making intelligent function module switch setting  
Only the common program is necessary.

### (3) Precautions

Do not perform the following operations of (a), (b), and (c) in the offset/gain setting mode. (If performed, an error occurs in the flash memory data and the Q66DA-G may not operate properly.)

- (a) Powering the programmable controller CPU.
- (b) Resetting the programmable controller CPU.
- (c) Performing an online module change.

## 5 UTILITY PACKAGE (GX Configurator-DA)

### 5.1 Utility Package Functions

Table 5.1 shows an overview of the utility package functions.

Table5.1 Utility package (GX Configurator-DA) function list

Item	Reference section	Description
Initial setting*1	<p>(1) Set the following items that require initial setting.</p> <ul style="list-style-type: none"> <li>• D/A conversion enable/disable setting</li> <li>• Scaling enable/disable setting</li> <li>• Scaling upper limit value/lower limit value</li> <li>• Rate control enable/disable setting</li> <li>• Increase/decrease digital limit value</li> <li>• Disconnection detection setting</li> <li>• Warning output setting</li> <li>• Warning output upper limit value/lower limit value</li> </ul> <p>(2) The data for which initial setting has been completed is registered in the parameters for the programmable controller CPU, and automatically written to the Q66DA-G when the programmable controller CPU changes to RUN status.</p>	Section 5.4
Automatic refresh setting	<p>(1) Sets automatic refresh for the Q66DA-G buffer memory.</p> <p>(2) The buffer memory that was set for automatic refresh is automatically read and written to the specified device when the END command for the programmable controller CPU is executed.</p>	Section 5.5
Monitor/Test	<p>(1) Monitor/Test The buffer memory and I/O signals for the Q66DA-G are monitored and tested.</p> <p>(2) Operating condition setting Changes the initial setting during operation.</p> <p>(3) Offset/gain setting When setting the offset/gain to a value selected by the user (when the analog output range setting is user range setting), the offset and gain can be easily set while viewing the screen.</p> <p>(4) Pass data The pass data (Pass data classification setting, Industrial shipment settings offset/gain value, User range settings offset/gain value) can be monitored and set.</p>	Section 5.6
FB conversion	Generates FB automatically from the intelligent function module parameter (initial setting/auto refresh setting).	Section 5.7

1	OVERVIEW
2	SYSTEM CONFIGURATION
3	SPECIFICATIONS
4	SETUP AND PROCEDURES BEFORE OPERATION
5	UTILITY PACKAGE (GX CONFIGURATOR-DA)
6	PROGRAMMING
7	ONLINE MODULE CHANGE
8	TROUBLESHOOTING

## 5.2 Installing and Uninstalling the Utility Package

---

For how to install or uninstall the utility package, refer to "Method of installing the MEL-SOFT Series" included in the utility package.

### 5.2.1 Handling precautions

---

The following explains the precautions on using the GX Configurator-DA:

**(1) For safety**

Since GX Configurator-DA is add-in software for GX Developer, read "Safety Precautions" and the basic operating procedures in the GX Developer Operating Manual.

**(2) About installation**

GX Configurator-DA is add-in software for GX Developer Version 4 or later. Therefore, GX Configurator-DA must be installed on the personal computer that has already GX Developer Version 4 or later installed.

**(3) Screen error of Intelligent function module utility**

Insufficient system resource may cause the screen to be displayed inappropriately while using the Intelligent function module utility. If this occurs, close the Intelligent function module utility, GX Developer (program, comments, etc.) and other applications, and then start GX Developer and Intelligent function module utility again.

**(4) To start the Intelligent function module utility**

- (a) In GX Developer, select "QCPU (Q mode)" for PLC series and specify a project. If any PLC series other than "QCPU (Q mode)" is selected, or if no project is specified, the Intelligent function module utility will not start.
- (b) Multiple Intelligent function module utilities can be started. However, [Open parameters] and [Save parameters] operations under [Intelligent function module parameter] are allowed for one Intelligent function module utility only. Only the [Monitor/test] operation is allowed for the other utilities.

## (5) Switching between two or more Intelligent function module utilities

When two or more Intelligent function module utility screens cannot be displayed side by side, select a screen to be displayed on the top of others using the task bar.



## (6) Number of parameters that can be set in GX Configurator-DA

When multiple intelligent function modules are mounted, the number of parameter settings must not exceed the following limit.

When intelligent function modules are installed to:	Maximum number of parameter settings	
	Initial setting	Auto refresh setting
Q00J/Q00/Q01CPU	512	256
Q02/Q02H/Q06H/Q12H/Q25HCPU	512	256
Q02PH/Q06PH/Q12PH/Q25PHCPU	512	256
Q12PRH/Q25PRHCPU	512	256
Q00UJ/Q00U/Q01UCPU	512	256
Q02UCPU	2048	1024
Q03UD/Q04UDH/Q06UDH/Q10UDH/Q13UDH/ Q20UDH/Q26UDH/Q03UDE/Q04UDEH/Q06UDEH/ Q10UDEH/Q13UDEH/Q20UDEH/Q26UDEHCPU	4096	2048
MELSECNET/H remote I/O station	512	256

For example, if multiple intelligent function modules are installed to MELSECNET/H remote I/O stations, configure the settings in GX Configurator-DA so that the number of parameter settings for all the intelligent function modules does not exceed the limit of the MELSECNET/H remote I/O stations.

Calculate the total number of parameter settings separately for the initial setting and for the auto refresh setting.

The number of parameters that can be set for one module in GX Configurator-DA is as shown below.

Target module	Initial setting	Auto refresh setting
Q66DA-G	5 (Fixed)	14 (Max.)

Example) Counting the number of parameter settings in Auto refresh setting

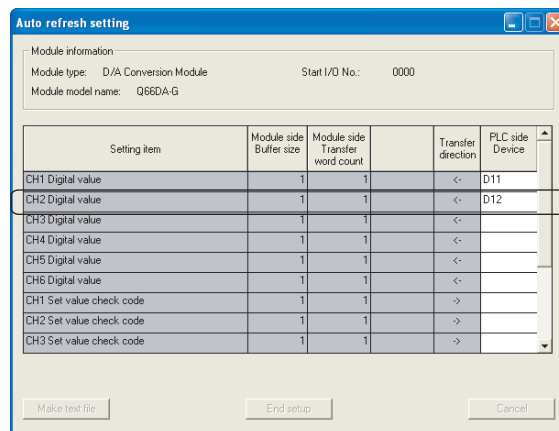

This one row is counted as one setting. Blank rows are not counted. Count up all the setting items on this screen, and add the total to the number of settings for other intelligent function modules to get a grand total.

## 5.2.2 Operating environment

This section explains the operating environment of the personal computer that runs GX Configurator-DA.

Item	Description			
Installation (Add-in) target <sup>*1</sup>	Add-in to GX Developer Version 4 (English version) or later <sup>*2</sup>			
Computer	A personal computer with any of the operating systems below			
<table border="1"> <tr> <td>CPU</td> <td rowspan="2">Refer to the next page "Operating system and performance required for personal computer".</td> </tr> <tr> <td>Required memory</td> </tr> </table>	CPU	Refer to the next page "Operating system and performance required for personal computer".	Required memory	
CPU	Refer to the next page "Operating system and performance required for personal computer".			
Required memory				
Hard disk space	65 MB or more			
	20 MB or more			
Display	800 × 600 dots or more resolution <sup>*3</sup>			
Operating system	Microsoft® Windows® 95 Operating System (English version) Microsoft® Windows® 98 Operating System (English version) Microsoft® Windows® Millennium Edition Operating System (English version) Microsoft® Windows NT® Workstation Operating System Version 4.0 (English version) Microsoft® Windows® 2000 Professional Operating System (English version) Microsoft® Windows® XP Professional Operating System (English version) SP1 or later Microsoft® Windows® XP Home Edition Operating System (English version) SP1 or later Microsoft® Windows Vista® Home Basic Operating System (English version) Microsoft® Windows Vista® Home Premium Operating System (English version) Microsoft® Windows Vista® Business Operating System (English version) Microsoft® Windows Vista® Ultimate Operating System (English version) Microsoft® Windows Vista® Enterprise Operating System (English version) Microsoft® Windows® 7 Starter Operating System (English version) <sup>*4</sup> Microsoft® Windows® 7 Home Premium Operating System (English version) <sup>*4</sup> Microsoft® Windows® 7 Professional Operating System (English version) <sup>*4</sup> Microsoft® Windows® 7 Ultimate Operating System (English version) <sup>*4</sup> Microsoft® Windows® 7 Enterprise Operating System (English version) <sup>*4</sup>			

- \*1: Install GX Configurator-DA in GX Developer Version 4 or higher of the same language. GX Developer (English version) and GX Configurator-DA (Japanese version) cannot be used in combination, and GX Developer (Japanese version) and GX Configurator-DA (English version) cannot be used in combination.
- \*2: GX Configurator-DA is not applicable to GX Developer Version 3 or earlier. In addition, GX Developer Version 8 or later is necessary to use the FB conversion function.
- \*3: When Windows® Vista or Windows® 7 is used, resolution of 1024 × 768 dots or more is recommended.
- \*4: When 32-bit Windows® 7 is used, add GX Configurator-DA Version 2.11M or later in GX Developer Version 8.91V or later.  
When 64-bit Windows® 7 is used, add GX Configurator-DA Version 2.11M or later in GX Developer Version 8.98C or later.



## Operating system and performance required for personal computer

Operating system	Performance required for personal computer	
	CPU	Memory
Windows® 95	Pentium® 133MHz or more	32MB or more
Windows® 98	Pentium® 133MHz or more	32MB or more
Windows® Me	Pentium® 150MHz or more	32MB or more
Windows NT® Workstation 4.0	Pentium® 133MHz or more	32MB or more
Windows® 2000 Professional	Pentium® 133MHz or more	64MB or more
Windows® XP	Pentium® 300MHz or more	128MB or more
Windows Vista®	Pentium® 1GHz or more	1GB or more
Windows® 7	Pentium® 1GHz or more	1GB or more (32-bit) 2GB or more (64-bit)

### ☒ Point

- (1) The functions shown below are not available for Windows® XP, Windows Vista®, and Windows® 7.

If any of the following functions is attempted, this product may not operate normally.

- Start of application in Windows® compatible mode
- Fast user switching
- Remote desktop
- Large fonts (Details setting of Display Properties)
- DPI setting other than 100%

Also, GX Configurator-DA is not supported by 64-bit Windows® XP and 64-bit Windows Vista® .

- (2) A user with USER authority or higher can access GX Configurator-DA for Windows Vista® and Windows® 7.
- (3) When Windows® 7 is used, the following functions are not available.
- Windows XP Mode
  - Windows Touch

## 5.3 Utility Package Operation

### 5.3.1 Common utility package operations

#### (1) Control keys

Special keys that can be used for operation of the utility package and their applications are shown in the table below.

Key	Application
Esc	Cancels the current entry in a cell. Closes the window.
Tab	Moves between controls in the window.
Ctrl	Used in combination with the mouse operation to select multiple cells for test execution.
Delete	Deletes the character where the cursor is positioned. When a cell is selected, clears all of the setting contents in the cell.
Back Space	Deletes the character where the cursor is positioned.
↑ ↓ ← →	Moves the cursor.
Page Up	Moves the cursor one page up.
Page Down	Moves the cursor one page down.
Enter	Completes the entry in the cell.

## (2) Data created with the utility package

The following data or files that are created with the utility package can be also handled in GX Developer. Fig5.1 shows respective data or files are handled in which operation.

### (a) Intelligent function module parameter

This represents the data created in Auto refresh setting, and they are stored in an intelligent function module parameter file in a project created by GX Developer.

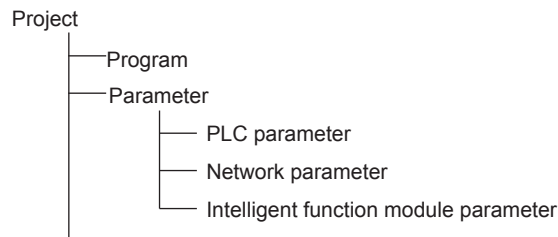

## (b) Text files

A text file can be created by clicking the **Make text file** button on the initial setting, Auto refresh setting, or Monitor/Test screen. The text files can be utilized to create user documents.

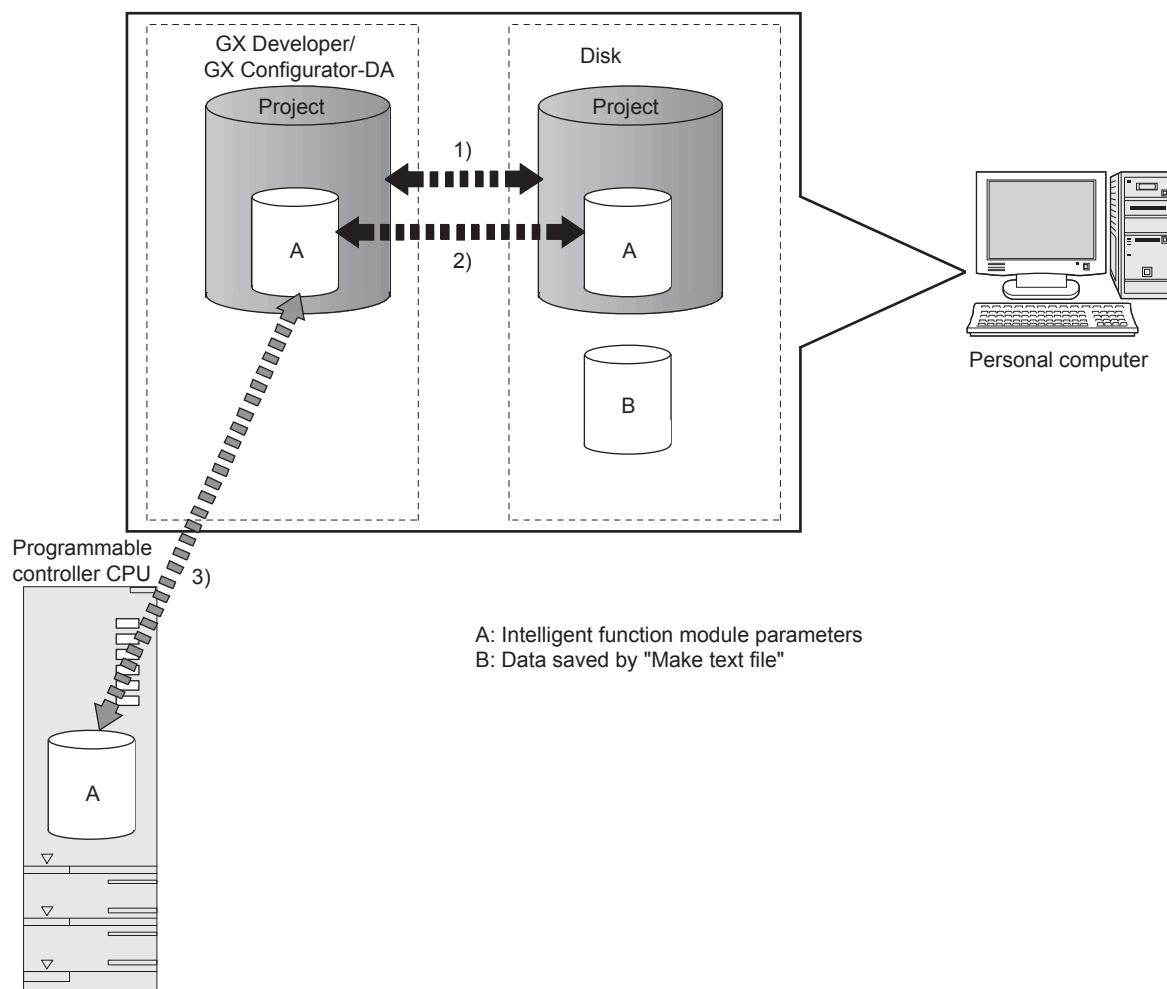

Fig5.1 Correlation chart for data created with the utility package

Steps 1) to 3) shown in Fig5.1 are performed as follows:

**1) From GX Developer, select:**

[Project] → [Open project] / [Save] / [Save as]

**2) On the intelligent function module selection screen of the utility, select:**

[Intelligent function module parameter] → [Open parameters] / [Save parameters]

**3) From GX Developer, select:**

[Online] → [Read from PLC] / [Write to PLC] "Intelligent function module parameters"

Alternatively, from the intelligent function module selection screen of the utility, select:

[Online] → [Read from PLC] / [Write to PLC]

## 5.3.2 Operation overview

GX Developer screen

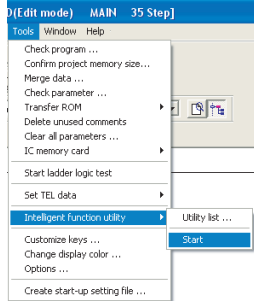

[Tools] - [Intelligent function utility] - [Start]

Screen for selecting a target intelligent function module

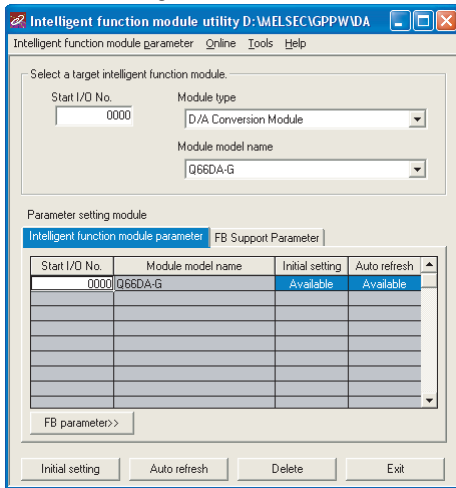

Enter "Start I/O No.", and select "Module type" and "Module model name".

Initial setting

Auto refresh

Initial setting screen

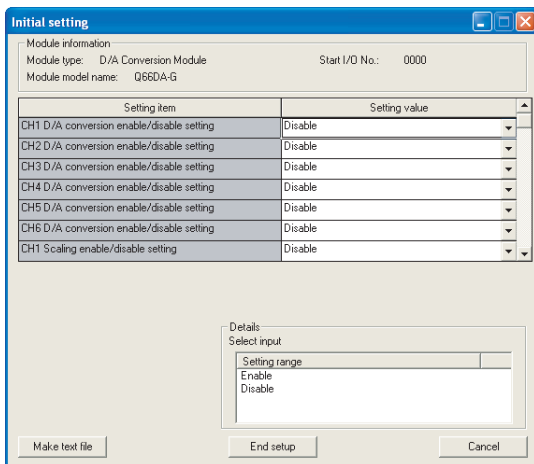

Refer to Section 5.4.

Auto refresh setting screen

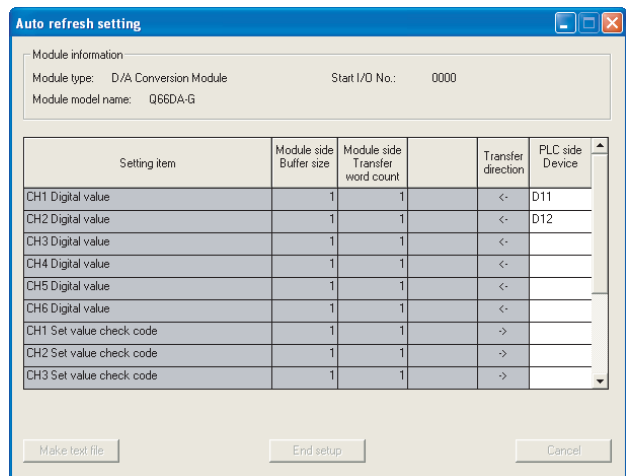

Refer to Section 5.5.

1) [Online] - [Monitor/Test] <<FB support parameter>> tab - [FB conversion]

Selecting monitor/test module screen

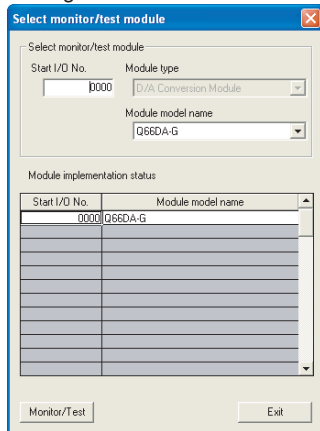

FB conversion screen

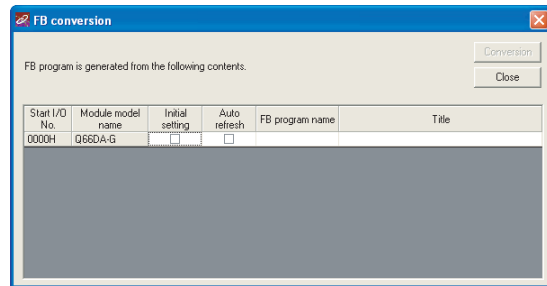

Refer to Section 5.7.

Select a module to be monitored/tested.

Monitor/Test screen

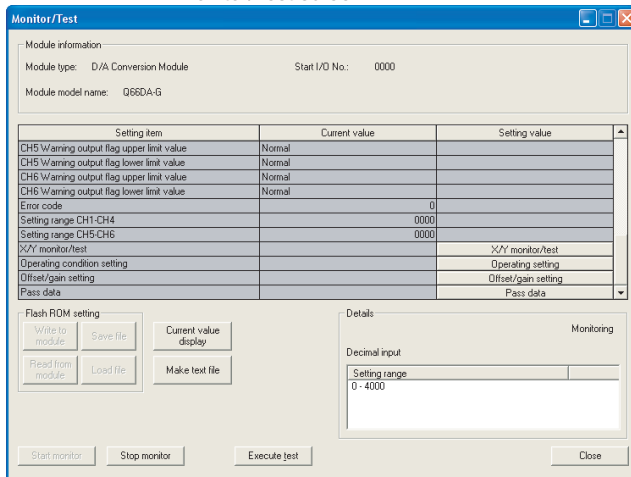

Refer to Section 5.6.

## 5.3.3 Starting the Intelligent function module utility

[Operating procedure]

Intelligent function module utility is started from GX Developer.

[Tools] → [Intelligent function utility] → [Start]

[Setting screen]

Displayed when the <<FB support parameter>> tab is selected

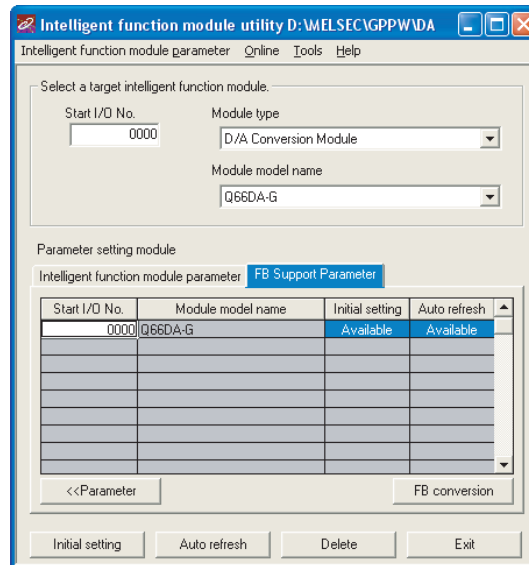

[Explanation of items]

### (1) Activation of other screens

The following screens can be displayed from the intelligent function module utility screen.

Common operations to the <<Intelligent function module parameter>> and <<FB support parameter>> tabs

#### (a) Initial setting screen

"Start I/O No. \*1" → "Module type" → "Module model name" → Initial setting

#### (b) Auto refresh setting screen

"Start I/O No. \*1" → "Module type" → "Module model name" → Auto refresh

#### (c) Select monitor/test module screen

[Online] → [Monitor/Test]

\*1 Enter the start I/O No. in hexadecimal.

On the <<FB support parameter>> tab

#### (a) FB conversion screen

<<FB support parameter>> tab → FB conversion

For details, refer to Section 5.7.

---

## Point

The <<FB support parameter>> tab is displayed when the project which is being edited is a label project.

---



## (2) Command buttons

Common operations to the <<Intelligent function module parameter>> and <<FB support parameter>> tabs

**Delete** Deletes the initial setting and auto refresh setting of the selected module.

However, with any initial setting and auto refresh setting present, selecting the cell of "initial setting" or "auto refresh" and executing it will delete only the setting of the selected cell.

**Exit** Closes this screen.

When the <<FB support parameter>> tab is selected

**<<Parameter** Moves the setting of the selected line to the <<Intelligent function module parameter>> tab.

When the <<Intelligent function module parameter>> tab is selected

**FB parameter>>** Moves the setting of the selected line to the <<FB support parameter>> tab.

## (3) Menu bar

### (a) File menu

Intelligent function module parameters of the project opened by GX Developer are handled.

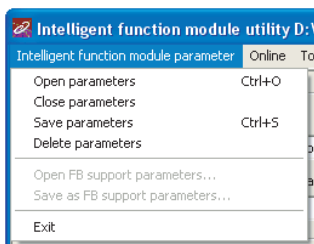

- [Open parameters]: Reads a parameter file.
- [Close parameters]: Closes the parameter file. If any data are modified, a dialog asking for file saving will appear.
- [Save parameters]: Saves the parameter file.
- [Delete parameters]: Deletes the parameter file.
- [Open FB support parameters]: Opens the FB support parameter file.
- [Save as FB support parameters]: Saves the FB support parameter file.
- [Exit]: Closes this screen.

### (b) Online menu

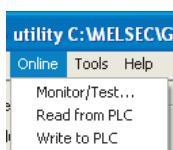

- [Monitor/Test]: Activates the Select monitor/test module screen.
- [Read from PLC]: Reads intelligent function module parameters from the CPU module.
- [Write to PLC]: Writes intelligent function module parameters to the CPU module.

---

## ☒ Point

---

- (1) Saving intelligent function module parameters in a file  
Since intelligent function module parameters cannot be saved in a file by the project saving operation of GX Developer, save them on the shown module selection screen for intelligent function module parameter setting.
  - (2) Reading/writing intelligent function module parameters from/to a programmable controller CPU using GX Developer
    - (a) Intelligent function module parameters can be read from and written into a programmable controller after having been saved in a file.
    - (b) Set a target programmable controller CPU in GX Developer: [Online] → [Transfer setup].
    - (c) When the Q66DA-G is installed to the remote I/O station, use "Read from PLC" and "Write to PLC".
  - (3) Checking the required utility  
While the start I/O is displayed on the Intelligent function module utility setting screen, "\*" may be displayed for the model name.  
This means that the required utility has not been installed or the utility cannot be started from GX Developer.  
Check the required utility, selecting [Tools] - [Intelligent function utility] - [Utility list...] in GX Developer.
-

## 5.4 Initial Setting

[Purpose]

Set the following initial setting parameters.

- D/A conversion enable/disable setting
- Rate control enable/disable setting
- Increase/decrease digital limit value
- Disconnection detection setting
- Warning output setting
- Warning output upper/lower limit value

Setting parameters in the Initial setting screen can omit parameter settings in sequence programs.

[Operating procedure]

"Start I/O No. \*1" → "Module type" → "Module model name" → Initial setting

\*1 Enter the start I/O No. in hexadecimal.

[Setting screen]

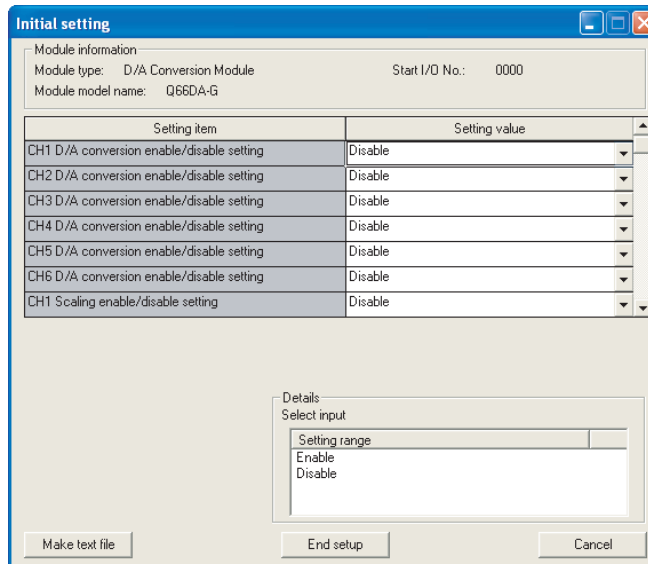

[Explanation of items]

### (1) Setting contents

Set D/A conversion enable/disable setting, Rate control enable/disable setting and others for each channel.

## (2) Command buttons

Make text file	Creates a file and writes the screen data in text file format.
End setup	Saves the set data and ends the operation.
Cancel	Cancels the setting and ends the operation.

## ☒ Point

---

Initial setting data are stored in intelligent function module parameters. After being written to the CPU module, the initial setting data are made effective by operating either (1) or (2).

- (1) Change the RUN/STOP switch of the CPU module: STOP → RUN → STOP → RUN.
- (2) After setting the RUN/STOP switch to RUN, power the programmable controller OFF → ON or reset the CPU module.

When using a sequence program to write initial setting data, the data will be written when the CPU module is switched from STOP to RUN. Create a program so that initial setting is re-executed in the sequence program.

---

## 5.5 Auto Refresh Setting

[Purpose]

Configure the Q66DA-G's buffer memory for automatic refresh.

[Operating procedure]

"Start I/O No. \*1\*" → "Module type" → "Module model name" → Auto refresh

\*1 Enter the start I/O No. in hexadecimal.

[Setting screen]

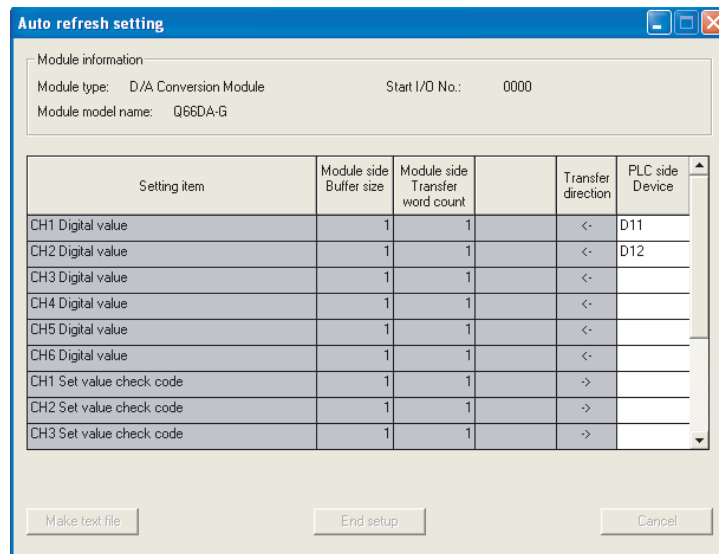

[Explanation of items]

## (1) Items

- Module side Buffer size : Displays the buffer memory size of the setting item (fixed at one word).
- Module side Transfer word count : Displays the number of words to be transferred to the CPU devices from the designated address (fixed at one word).
- Transfer direction : "←" indicates that data are written from the device to the buffer memory.  
"→" indicates that data are loaded from the buffer memory to the device.
- PLC side Device : Enter a CPU module side device that is to be automatically refreshed.  
Applicable devices are X, Y, M, L, B, T, C, ST, D, W, R, and ZR.  
When using bit devices X, Y, M, L or B, set a number that can be divided by 16 points (examples: X10, Y120, M16, etc.)  
Also, buffer memory data are stored in a 16-point area, starting from the specified device number.  
For example, if X10 is entered, data are stored in X10 to X1F.

## (2) Command buttons

<input type="button" value="Make text file"/>	Creates a file and writes the screen data in text file format.
<input type="button" value="End setup"/>	Saves the set data and ends the operation.
<input type="button" value="Cancel"/>	Cancels the setting and ends the operation.

### Point

Auto refresh setting data are stored in intelligent function module parameters. After being written to the CPU module, the auto refresh setting data are made effective by operating either (1) or (2).

- (1) Change the RUN/STOP switch of the CPU module: STOP → RUN → STOP → RUN.
- (2) After setting the RUN/STOP switch to RUN, power the programmable controller OFF → ON or reset the CPU module.

The auto refresh settings cannot be changed from sequence programs.

However, processing equivalent to auto refresh can be added using the FROM/TO instruction in the sequence program.

## 5.6 Monitoring/Test

### 5.6.1 Monitor/test screen

**[Purpose]**

Start buffer memory monitoring/testing, I/O signal monitoring/testing, operating condition setting, offset/gain settings (refer to Section 5.6.2) and pass data (refer to Section 5.6.3) from this screen.

**[Operating procedure]**

"Select monitor/test module" screen → "Start I/O No. \*1" → "Module type" → "Module model name" → Monitor/test

\*1 Enter the start I/O No. in hexadecimal.

The screen can also be started from System monitor of GX Developer Version 6 or later.

Refer to the GX Developer Operating Manual for details.

**[Setting screen]**

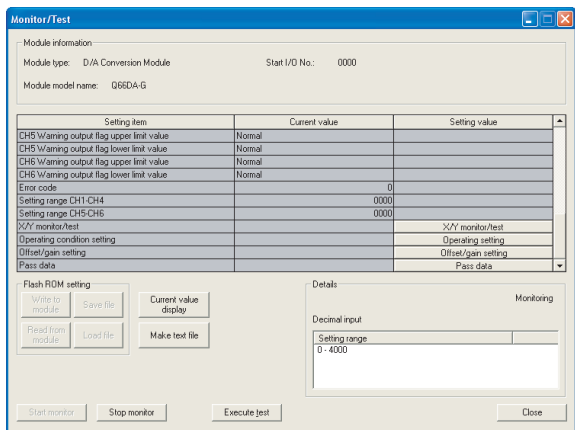

X/Y monitor/test

Operating setting

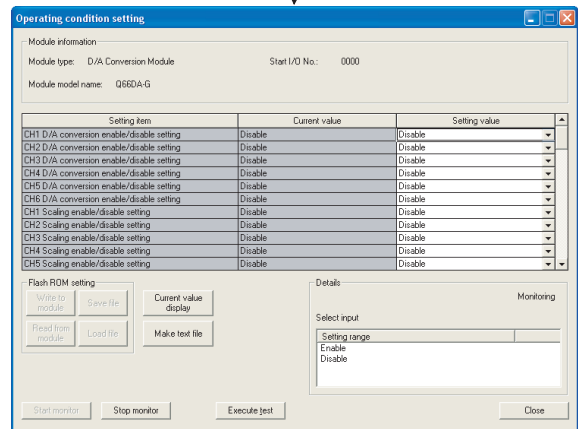
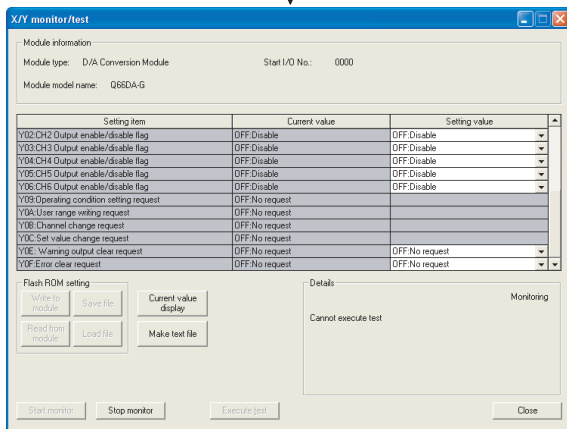



1)

Offset/gain setting

Pass data

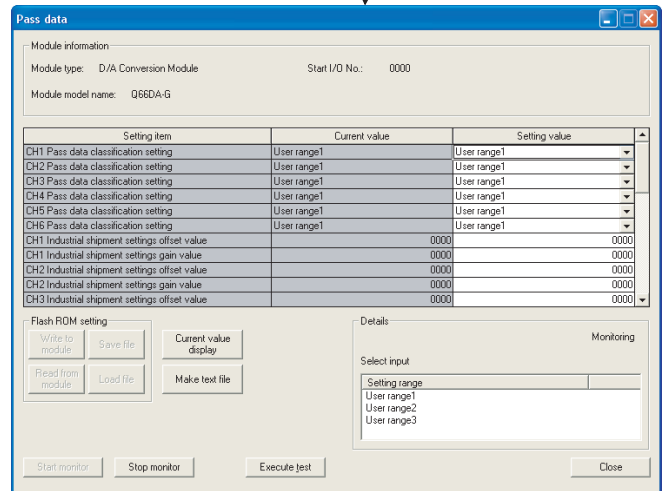
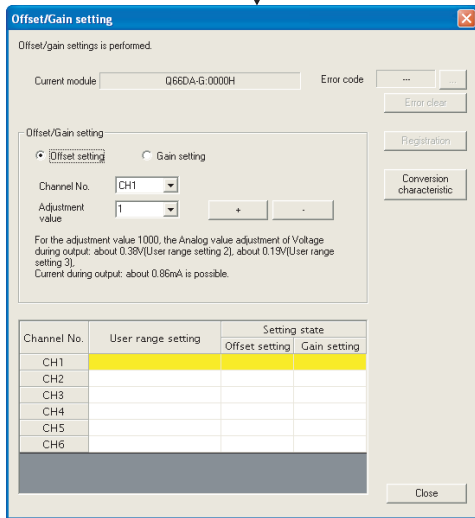

Conversion characteristic

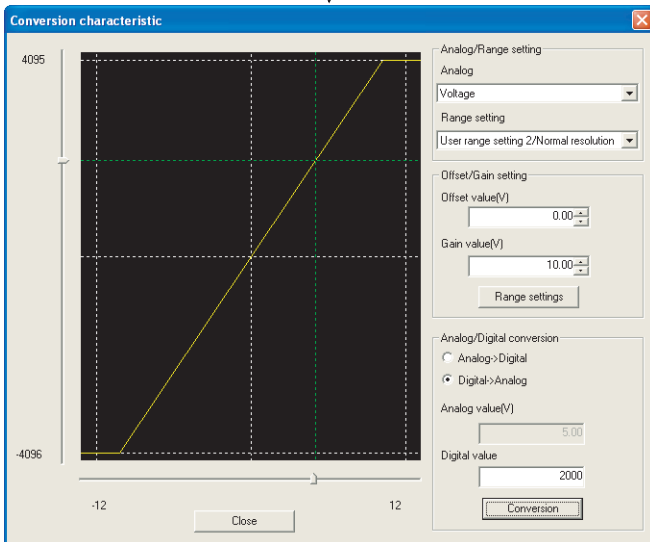

[Explanation of items]

## (1) Items

- Setting item : Displays buffer memory names.
- Current value : Monitors the present buffer memory values.
- Setting value : Enter or select values to be written into the buffer memory for test operation.

## (2) Command buttons

<input type="button" value="Current Value"/>	Displays the current value of the item selected. (This is used to check the text that cannot be displayed in the current value field. However, in this utility package, all items can be displayed in the display fields.)
<input type="button" value="Make text file"/>	Creates a file and writes the screen data in text file format.
<input type="button" value="Start monitor"/> / <input type="button" value="Stop monitor"/>	Selects whether or not to monitor current values.
<input type="button" value="Execute test"/>	Performs a test on the selected items. To select more than one item, select them while holding down the <input type="button" value="Ctrl"/> key.
<input type="button" value="Close"/>	Closes the currently open screen and returns to the previous screen.

## Point

- (1) Turning on or off an output enable/disable flag or writing CH  Digital value during test operation changes the analog output, so perform these after ensuring the safety.

## (3) Example of using "Execute test"

The following explains the case of forcing CH1 Output enable/disable flag (Y1) to turn on.

- (a) Click the  button in the Monitor/Test screen.
- (b) Change the "Y1: CH1 Output enable/disable flag" setting to "ON: enable."  
At this point, this setting is not written to the Q66DA-G.
- (c) Select the field, of which setting value was changed in step (b).  
(When multiple items were changed in (b), select the fields while holding down the Ctrl key. Multiple fields can be selected by dragging the mouse over them.)
- (d) Click the  button to write the data.  
After the writing is completed, the written values are displayed in the "Current value" field.

## 5.6.2 Offset/gain setting operation

Perform the offset/gain setting operation in the following sequence.

### (1) Switch to the offset/gain setting screen

Perform the operation in Section 5.6.1 to display the offset/gain setting screen. At this point, a dialog box to confirm the transition of Q66DA-G's operation mode (normal mode -> offset/gain setting mode) is displayed. Click the  button to transit to the offset/gain setting mode.

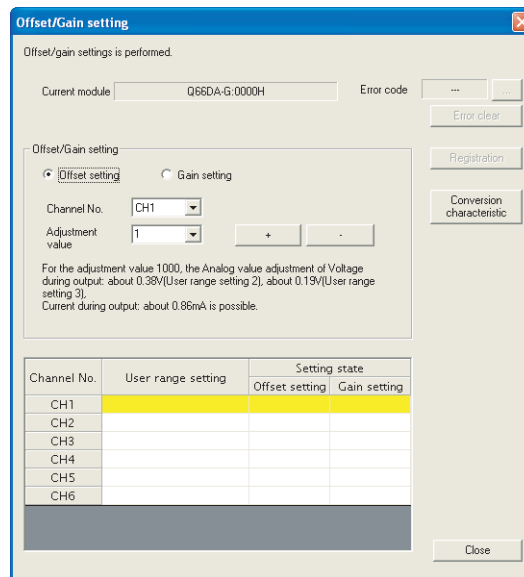

### (2) Specify a channel

Specify the target channel of offset setting or gain setting on the channel No. combo box.

### (3) Specify offset/gain setting

Specify either offset setting or gain setting on the channel specified on the channel No. combo box using the radio button.

### (4) Specify the user range setting

Specify a user range used for the offset/gain setting of each channel on the combo box.

## (5) Set up adjustment values

Set up an adjustment value of the offset value or gain value. Select "1", "10", "100", or "1000" on the combo box, however, you can also set up adjustment values by entering a number (1 to 3000).

## (6) Fine adjustment of voltage output or current output

By clicking the  button or  button, the value of voltage output or current output for the prepared adjustment value is finely adjusted.

## (7) Write settings into the Q66DA-G

Write the content set by operations (2) to (6) into the Q66DA-G by clicking the

button.

### (a) Precautions

Do not perform the following operations during writing the content set by clicking the  button into the module. If performed, an error occurs in Flash memory data and the Q66DA-G may not operate properly.

- Power off the programmable controller CPU.
- Reset the programmable controller CPU.

## (8) Switch to the normal mode

When the offset/gain setting screen is closed by clicking the  button after the setting operation has finished, Q66DA-G's operation mode transits to the normal mode.

## Point

---

If an error code is displayed while performing the setting operation, the details and measure of the error can be confirmed by clicking the  button to the right of the error code display area. In addition, the error code can be cleared by clicking the  button.

---

## 5.6.3 Confirmation of Conversion Characteristic

[Purpose]

The converted value of digital-analog conversion can be confirmed according to the tilt of the graph, based on the offset/gain setting.

[Operating procedure]

Monitor/Test screen → offset/gain setting → Conversion characteristic

[Setting screen]

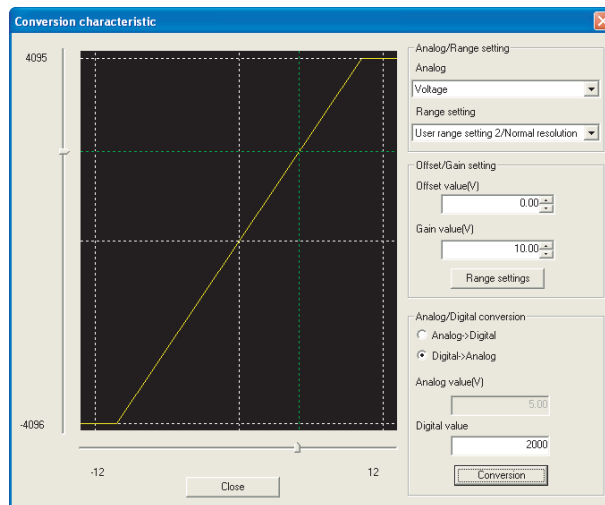

[Explanation of items]

(1) Items

I/O characteristic diagram: Displays the I/O conversion characteristic to the prepared offset/gain setting.

(2) Setting details

Analog and Range setting

Analog: Select the output (voltage/current) when a digital value is converted to an analog value.

Range setting: Select either "User range setting 2" or "User range setting 3." However, if "Current" is selected for the "Analog" item, only "User range setting 1" can be selected.

Offset/Gain setting

Offset value: Enter an offset value to display the I/O characteristic diagram.

Gain value: Enter a gain value to display the I/O characteristic diagram.

Analog/digital conversion: Select a conversion type shown below for confirming the correspondence between an analog value and a digital value caused by the conversion characteristic.

- Digital → Analog

- Analog → Digital

Analog value: <When converted to a digital value>

Enter an analog value to be converted to a digital value

<When converted to an analog value>

The analog value converted from a digital value is displayed.

Digital value: <When converted to a digital value>

The digital value corresponding to an entered analog value is displayed.

<When converted to an analog value>

Enter a digital value to be converted to an analog value.

## ☒ Point

- The offset value is the analog output value (voltage or current) when a digital entry value of 0 is set from the programmable controller CPU.
- The gain value is the analog value (voltage or current) output when the digital input value set from the programmable controller CPU is as follows:

Normal resolution mode	4000 (User range setting 1 to 3)
High resolution mode	12000 (User range setting 1 to 3)

### (3) Command button

Range setting

The entered offset/gain value is determined, and the I/O characteristic diagram is updated.

Conversion

Conversion for the entered value is performed.

## 5.6.4 Pass data

Save and restore the user range data in the following sequence.

### (1) Switch to the Pass data screen

Perform the operation in Section 5.6.1 to display the Pass data screen.

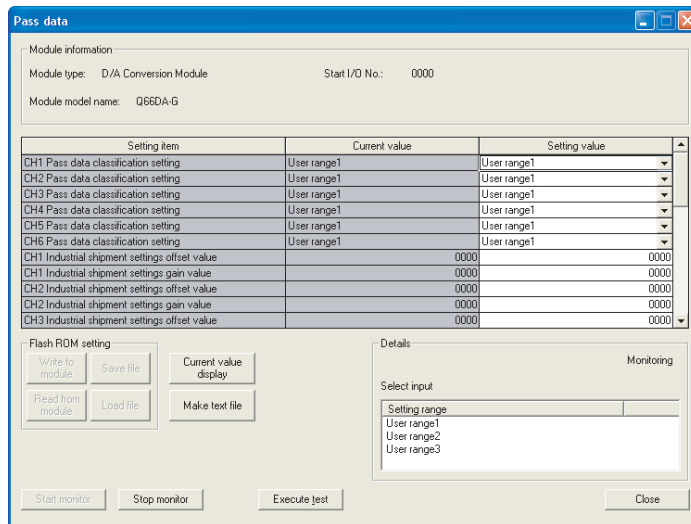

### (2) User range saving

- (a) Set the user range to be used in the Setting value field of CH□ Pass data classification setting, and click the **Execute test** button.  
When the user range setting is completed, it is displayed in the Current value field of CH□ Pass data classification setting.
- (b) Change the Setting value field of Pass data read request to "Request", and click the **Execute test** button.  
When reading is completed, the values are displayed in the Current value fields of CH□ Industrial shipment settings offset/gain values/CH□ User range settings offset/gain values.
- (c) Compare the values with those in the range reference table, and record them if they are correct.  
Refer to Section 7.4 for the range reference table.

### (3) User range restoration

- (a) Set the user range to be used in the Setting value field of CH□ Pass data classification setting, and click the  button.  
When the user range setting is completed, the set user range is displayed in the current value field of CH□ Pass data classification setting.
- (b) Set the recorded values in the Setting value fields of CH□ Industrial shipment settings offset/gain values/user range settings offset/gain values.
- (c) Select all the Setting value fields of CH□ Industrial shipment settings offset/gain values/user range settings offset/gain values, and click the  button.  
When writing is completed, the set values are displayed in the Current value fields of CH□ Industrial shipment settings offset/gain values/CH□ User range settings offset/gain values.
- (d) Change the Setting value field of Pass data write request to "Request", and click the  button.  
Make sure that the indication in the Current value field of Pass data write request changes from "Request" to "OFF" on completion of writing.



## 5.7 FB Conversion of Initial Setting/Auto Refresh Setting

[Purpose]

FB is generated automatically from the intelligent function module parameter (initial setting/auto refresh setting).

[Operating procedure]

Intelligent Function Module Parameter Setting Module Selection Screen

<<FB Support Parameter>> tab → FB conversion

[Setting screen]

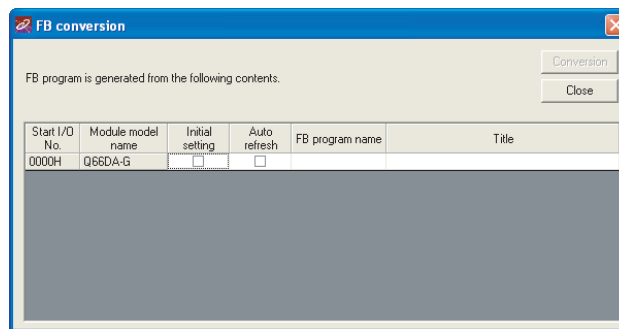

[Explanation of items]

(1) Items

- Start I/O No : The start I/O No. of the information which is set up on the currently open intelligent function module parameter is displayed.
- Module model name : The module model name of the information which is set up on the currently open intelligent function module parameter is displayed.
- Initial setting : Set up whether to apply FB conversion to the parameter or not.  
Check if you apply FB conversion to the parameter.
- Auto refresh : Set up whether to apply FB conversion to the parameter or not.  
Check if you apply FB conversion to the parameter.

- FB program name : Set up the name of the converted FB program.  
Up to six single-byte characters can be set up as an FB program name.  
However, the characters and terms shown below cannot be set up as FB program name.  
Character: \, /, :, ;, \*, ?, ", <, >, |, ,, ,, ,,  
Term: COM1 to COM9, LPT1 to LPT9, AUX, PRN, CON, NUL, CLOCK\$  
In addition, I- is added for initial setting and A- is added for auto refresh setting respectively to the top of the FB name setting to be registered in GX Developer after FB conversion is performed.  
Ex.: If the FB program name is "ABCDE", the initial setting is "I-ABCDE" and the auto refresh setting is "A-ABCDE".
- Title : Set up a title on a converted FB program. Up to 32 single-byte characters can be set up as a title.

## (2) Command buttons

- Conversion FB conversion is performed for the checked columns of initial setting and auto refresh setting.

## 5.8 Usage of FB

This section describes the procedure for using FB with GX Developer.  
Refer to the "GX Developer Version 8 Operating Manual (Function Block)" for details.

### 5.8.1 Outline

The procedure for creating FB is shown below.

- 1) Set up the intelligent function module parameter (initial setting/auto refresh setting).
- 2) Convert the intelligent function module parameter into FB.
- 3) Paste the FB to a sequence program.
- 4) Convert (compile) the sequence program.

Next, a flowchart of procedures 1) to 4) is shown below.

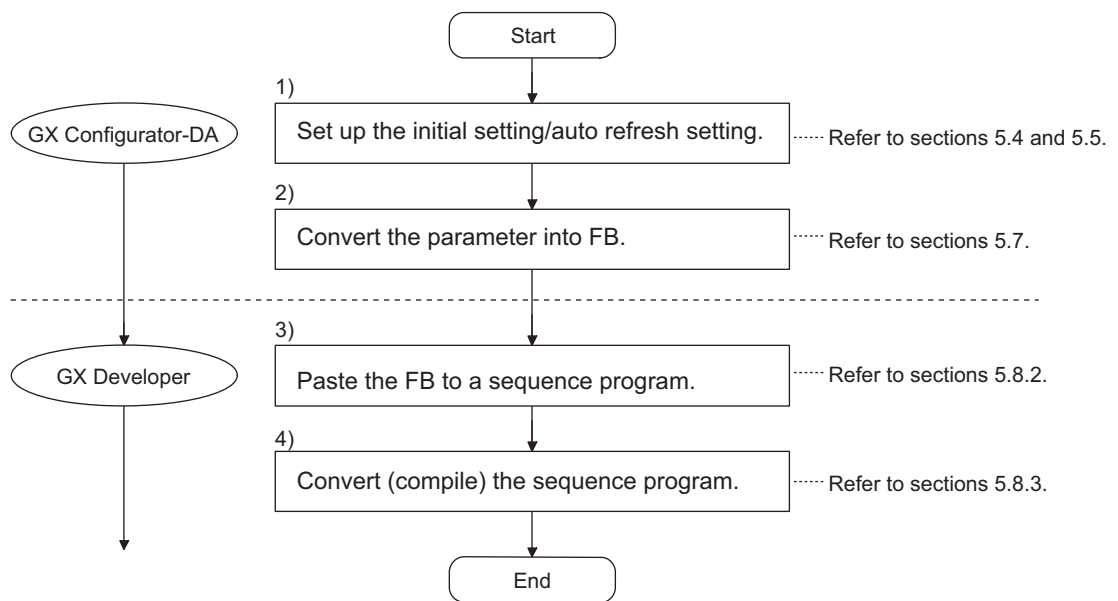

---

## ☒ Point

The initial setting/auto refresh setting of the intelligent function module can be performed by each of the following methods.

- (1) Set intelligent function parameters (Initial setting/Auto refresh setting) and write them to the programmable controller CPU.
- (2) Create an FB of the intelligent function module parameter (initial setting/auto refresh setting) and paste it to the sequence program.

In accordance with the specification of the system, perform the initial setting/auto refresh setting of the intelligent function module by one of the methods above.\*1

\*1 The following explains the case in which both of (1) and (2) are performed.

(a) Initial setting

FB setting given in (2) is valid.

(b) Auto refresh setting

- Both (1) and (2) are valid.
  - At the time of FB execution and in the END processing of the sequence program, automatic refresh is performed.  
Therefore, an analog value corresponding to the specified digital value is output at each auto refresh time.
-

## 5.8.2 Paste an FB to a Sequence Program

[Purpose of operation]

Paste an FB in order to use it with a sequence program.

[Operation procedure]

Switch the <<Project>> tab into the <<FB>> tab on GX Developer, and drag & drop the FB to be used onto the sequence program.

Before pasting

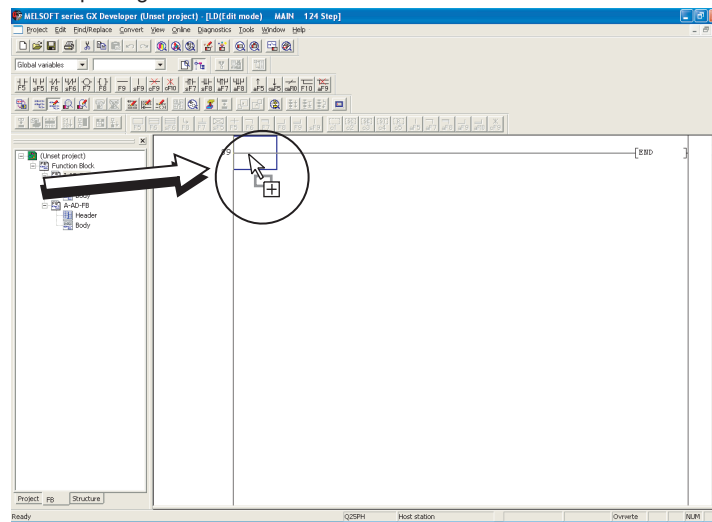

After pasting

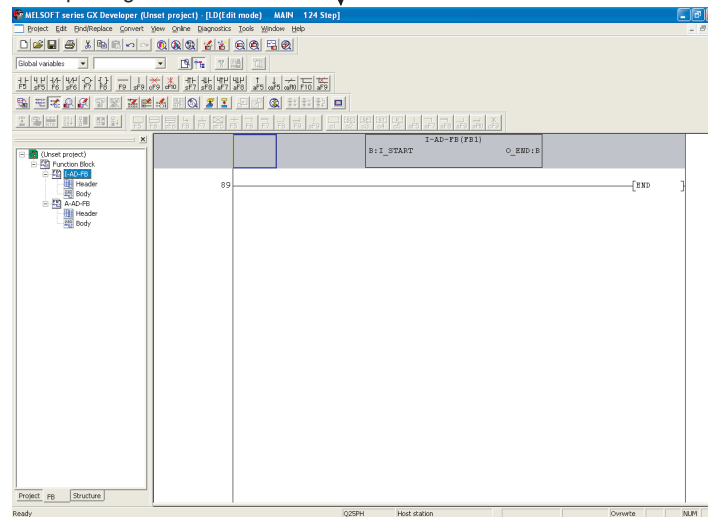

## 5.8.3 Convert (Compile) a Sequence Program

[Purpose of operation]

Convert (compile) the sequence program to which an FB was pasted so that it can be executed.

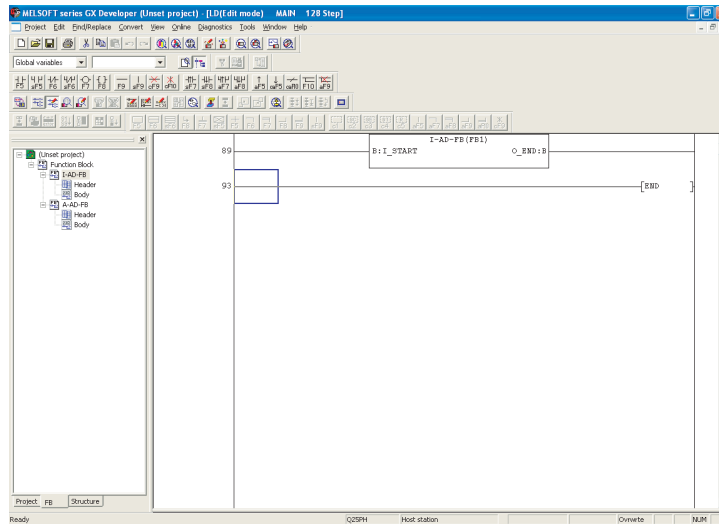

[Operation procedure]

Click the [Convert] menu → [Convert/Compile] menu of GX Developer.

## 6 PROGRAMMING

This chapter describes the programs of the Q66DA-G.

When applying any of the program examples introduced in this chapter to the actual system, verify the applicability and confirm that no problems will occur in the system control.

### 6.1 Programming Procedure

Create the program that will execute the digital-analog conversion of the Q66DA-G in the following procedure.

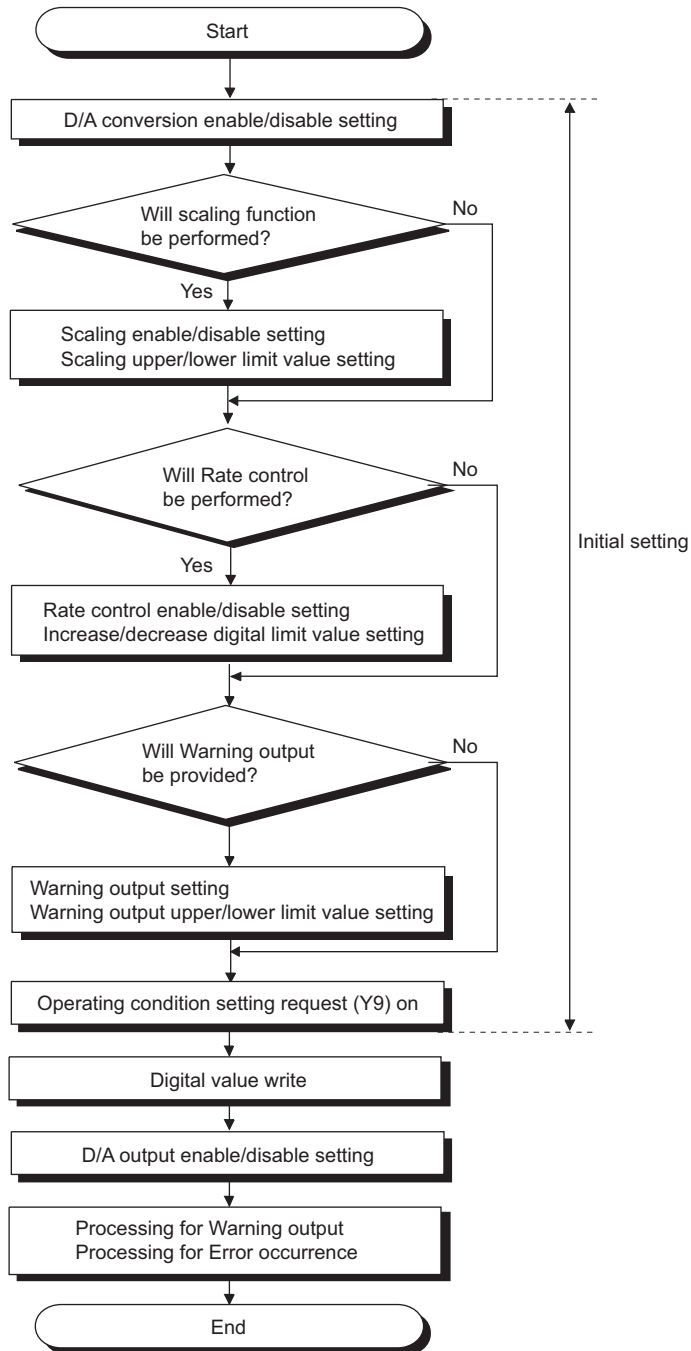

1	OVERVIEW
2	SYSTEM CONFIGURATION
3	SPECIFICATIONS
4	SETUP AND PROCEDURES BEFORE OPERATION
5	UTILITY PACKAGE (GX CONFIGURATOR-DA)
6	<b>PROGRAMMING</b>
7	ONLINE MODULE CHANGE
8	TROUBLESHOOTING

## 6.2 For Use in Normal System Configuration

### (1) System configuration

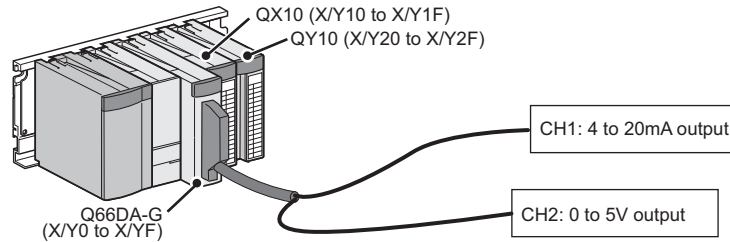

### (2) Conditions for the intelligent function module switch setting

	Input range setting	HOLD/CLEAR function setting	Normal resolution mode/ High resolution mode
CH1	4 to 20mA	CLEAR	High resolution mode
CH2	0 to 5V		
CH3 to CH6	not used	-	-

### (3) Program conditions

(a) CH1 uses the rate control function (Refer to Section 3.2.4.)

- CH1 Increase digital limit value: 100
- CH1 Decrease digital limit value: 30

(b) CH2 uses the warning output function (Refer to Section 3.2.4.)

- CH2 Warning output upper limit value: 10000
- CH2 Warning output lower limit value: 3000

If a warning is output, the status of Warning output flag (Un\G48) is read and processing for the warning output is performed.

(c) If an error occurs in writing a digital value, an error code is displayed in binary coded decimal (BCD) form.

Error code shall be reset after removing of the cause.



## 6.2.1 Before creating a program

Perform the following steps before creating a program.

### (1) Wiring of external devices

Mount the Q66DA-G on the base unit and connect the external devices.

- CH1: run the cables for current output. (For details, refer to “4.4.2 (2).)”)
- CH2: run the cables for voltage output. (For details, refer to “4.4.2 (1).)”)

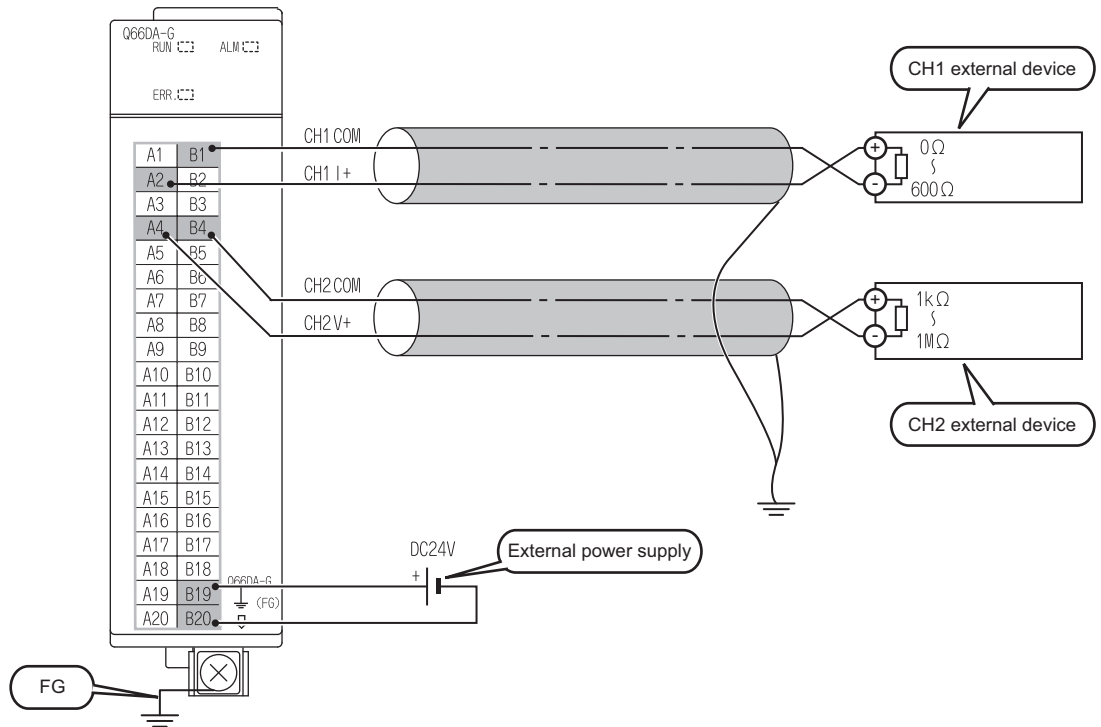

## (2) Intelligent function module switch setting

Based on the setting conditions given in Section 6.2 (2), make the intelligent function module switch settings.

(a) Each switch setting

### 1) Switches 1 and 2: Output range setting

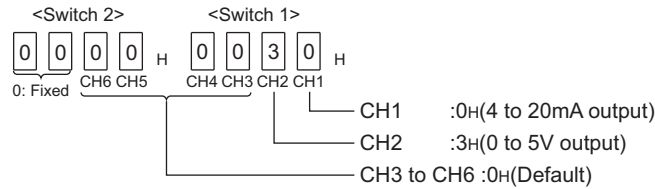

### 2) Switch 3: HOLD/CLEAR setting function

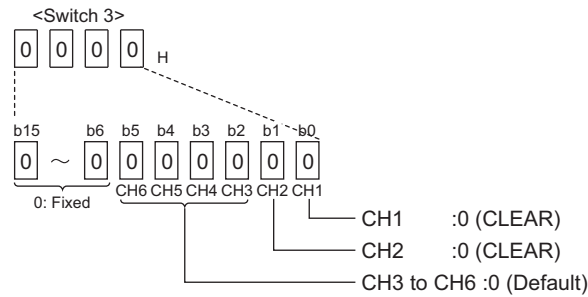

### 3) Switch 4: Mode setting

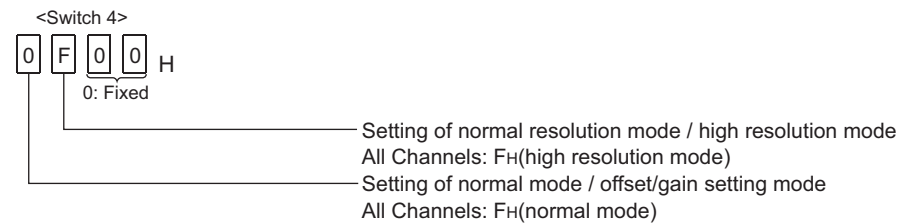

### 4) Switch 5: Use prohibited (0:Fixed\*1)

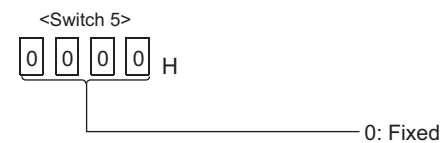

\*1 If any other than 0 is set to Switch 5, an error occurs.

(b) Write the settings in (a) to the Q66DA-G.

On GX Developer's "Parameter setting" screen, select the "I/O assignment" tab, click "Switch setting", and make settings of Switch 1 to 5 on the screen shown below.

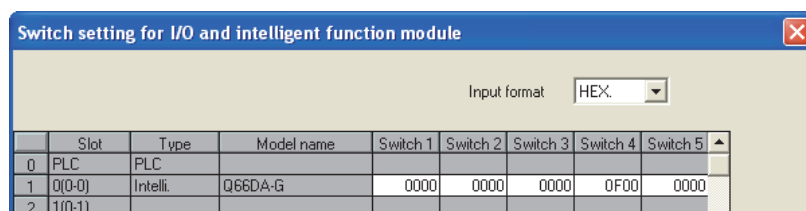

## 6.2.2 Program example using the utility package

### (1) List of devices

Device	Function	
D11 <sup>*1</sup>	CH1 Digital value	
D12 <sup>*1</sup>	CH2 Digital value	
D16 <sup>*1</sup>	Warning output flag	
D17 <sup>*1</sup>	Error code	
M20,M21	CH1 Warning output flag <sup>*2</sup>	
M22,M23	CH2 Warning output flag	
X0	Module READY	Q66DA-G (X/Y0 to X/YF)
X7	External power supply READY	
XE	Warning output signal	
XF	Error flag	
Y1	CH1 Output enable/disable flag	
Y2	CH2 Output enable/disable flag	
YE	Warning output clear request	
YF	Error clear request	
X11	Output enable	QX10 (X10 to X1F)
X12	Digital value write signal	
X14	Warning output reset signal	
X15	Error code reset signal	
Y20 to Y2B	Error code display (BCD 3 digits)	QY10 (Y20 to Y2F)

\*1 Devices used for the automatic refresh function of GX Configurator-DA.

\*2 Although channel 1 does not use warning output, these devices are assigned to read out data of Warning output flag of both channel 1 and 2 at a time.

## (2) Operation of utility package

- (a) Initial settings (Refer to Section 5.4)
  - CH1, CH2 D/A conversion enable/disable setting "Enable"
  - CH1 Rate control enable/disable setting "Enable"
  - CH1 Increase digital limit value "100"
  - CH1 Decrease digital limit value "30"
  - CH2 Warning output setting "Enable"
  - CH2 Warning output upper limit value "10000"
  - CH2 Warning output lower limit value "3000"

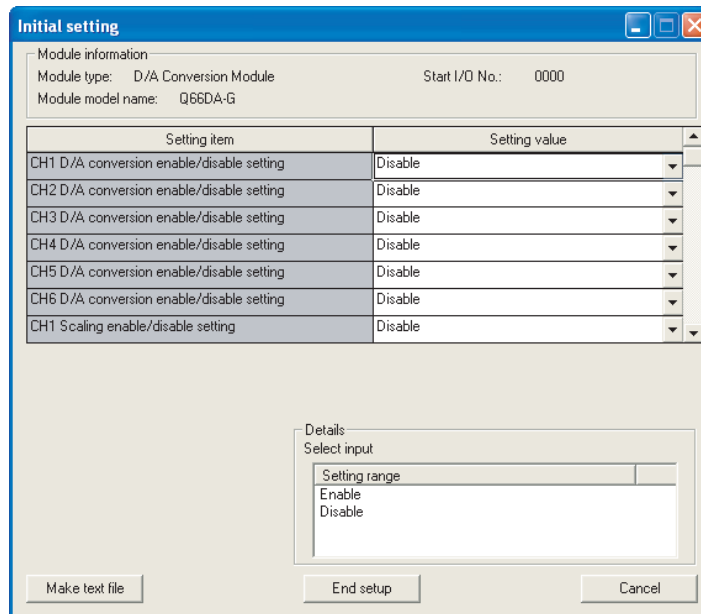

- (b) Automatic refresh setting (Refer to Section 5.5)
  - CH1, CH2 digital values D11, D12
  - Warning output D16
  - Error code D17

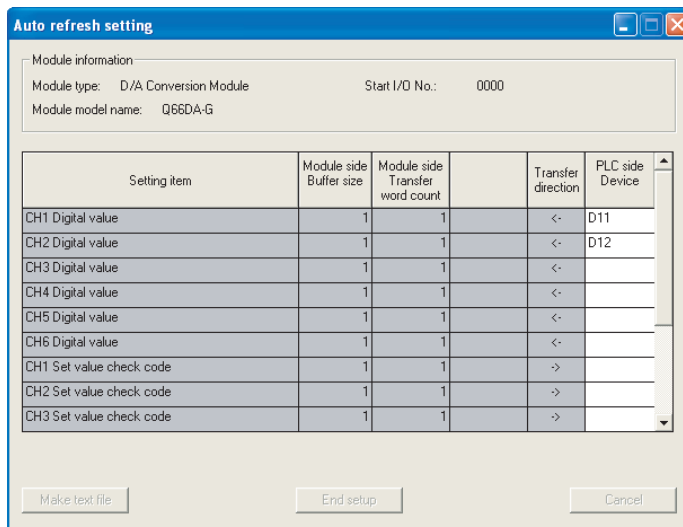

- (c) Write of intelligent function module parameters (Refer to Section 5.3.3)  
 Write the intelligent function module parameters to the CPU module. Perform this operation on the parameter setting module selection screen.

### (3) Program example

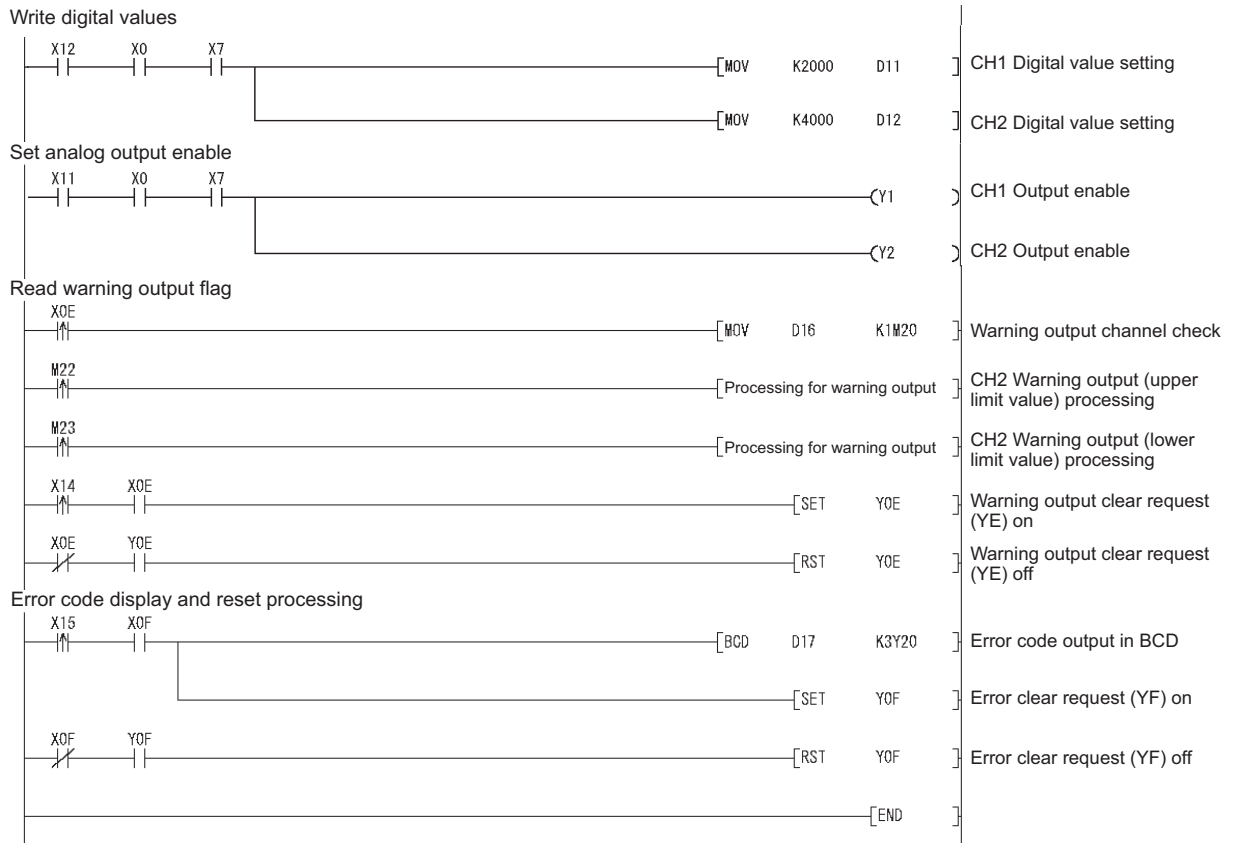

## 6.2.3 Programming example without using the utility package

### (1) List of devices

Device	Function	
M0	Module READY check flag	
M20,M21	CH1 Warning output flag <sup>*1</sup>	
M22,M23	CH2 Warning output flag	
X0	Module READY	Q66DA-G (X/Y0 to X/YF)
X7	External power supply READY	
X9	Operating condition setting completed flag	
XE	Warning output signal	
XF	Error flag	
Y1	CH1 Output enable/disable flag	
Y2	CH2 Output enable/disable flag	
Y9	Operating condition setting request	
YE	Warning output clear request	
YF	Error clear request	
X11	Output enable	QX10 (X10 to X1F)
X12	Digital value write signal	
X14	Warning output reset signal	
X15	Error code reset signal	
Y20 to Y2B	Error code display (BCD 3 digits)	QY10 (Y20 to Y2F)

<sup>\*1</sup> Although channel 1 does not use warning output, these devices are assigned to read out data of Warning output flag of both channel 1 and 2 at a time.

## (2) Program example

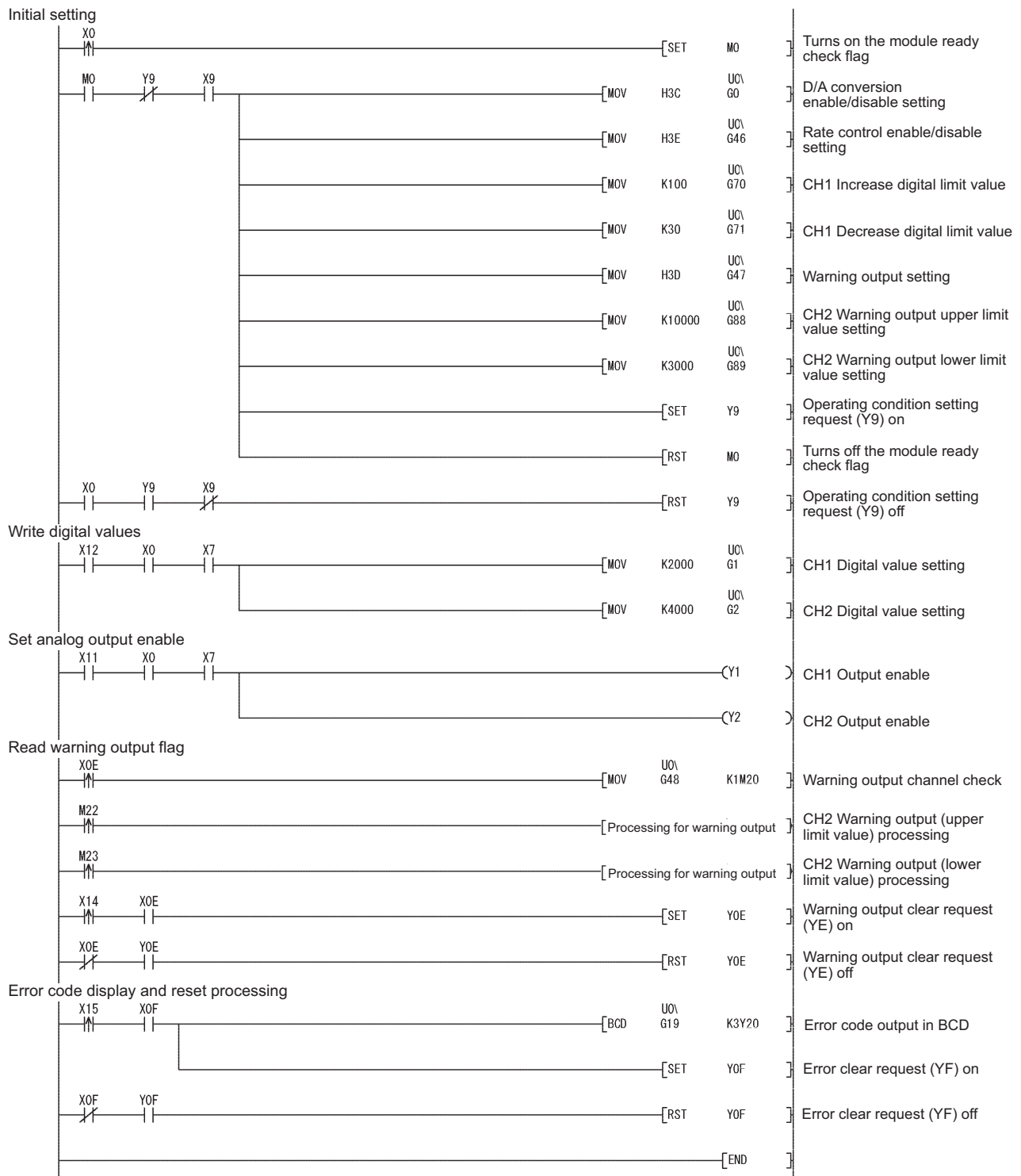

## 6.3 For Use on Remote I/O Network

### (1) System configuration

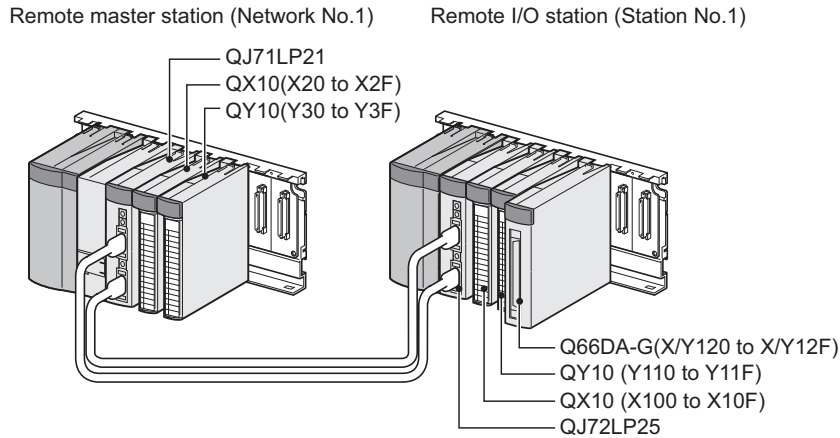

### (2) Conditions for the intelligent function module switch setting

	Input range setting	HOLD/CLEAR function setting	Normal/High resolution mode
CH1	4 to 20mA	CLEAR	High resolution mode
CH2	0 to 5V		
CH3 to CH6	not used	-	-

Based on the setting conditions given in the above, make the intelligent function module switch settings.

Select the [I/O assignment] tab on the [Intelligent function module switch settings] screen, and click [Switch setting] to set the following values.

Switch No.	Setting value
Switch 1	0030H
Switch 2	0000H
Switch 3	0000H (CH1,CH2: CLEAR)
Switch 4	0F00H (High resolution mode)
Switch 5	0000H (0: Fixed)

(CH1: 4 to 20mA, CH2: 0 to 5V, CH3 to CH6: Default)



### (3) Program conditions

- (a) CH1 uses the rate control function (Refer to Section 3.2.4.)
  - CH1 Increase digital limit value: 100
  - CH1 Decrease digital limit value: 30
- (b) CH2 uses the warning output function (Refer to Section 3.2.3.)
  - CH2 Warning output upper limit value: 10000
  - CH2 Warning output lower limit value: 3000

If a warning is output, Warning output flag status is read and processing for the warning output is performed.
- (c) If an error occurs in writing a digital value, an error code is displayed in binary coded decimal (BCD) form.  
Error code shall be reset after removing of the cause.

### (4) List of devices

Device	Function	
W11 <sup>*1</sup>	CH1 Digital value	
W12 <sup>*1</sup>	CH2 Digital value	
W116 <sup>*1</sup>	Warning output flag	
W117 <sup>*1</sup>	Error code	
M20,M21	CH1 Warning output flag <sup>*2</sup>	
M22,M23	CH2 Warning output flag	
X20	Initial setting request signal <sup>*3</sup>	QX10 (X20 to X2F)
X21	Output enable	
X22	Digital value write signal	
X24	Warning output reset signal	
X25	Error code reset signal	
Y30 to Y3B	Error code display (BCD 3 digits)	QY10 (Y30 to Y3F)
X120	Module READY	
X127	External power supply READY	
X129	Operating condition setting completed flag	
X12E	Warning output signal	
X12F	Error flag	
Y121	CH1 Output enable/disable flag	
Y122	CH2 Output enable/disable flag	
Y129	Operating condition setting request	
Y12E	Warning output clear request	
Y12F	Error clear request	

\*1 Devices used for the automatic refresh function of GX Configurator-DA.

\*2 Although channel 1 does not use warning output, these devices are assigned to read out data of Warning output flag of both channel 1 and 2 at a time.

\*3 When the initial setting is made by GX Configurator-DA, X20 is not used.

### ☒ Point

For details on the MELSECNET/H remote I/O network, refer to the Q Corresponding MELSECNET/H Network System Reference Manual (Remote I/O Network).

## 6.3.1 Program example using the utility package

### (1) Operating GX Developer

#### (a) Network parameter setting

- Network type : MNET/H (remote master)
- Head I/O No. : 0000H
- Network No. : 1
- Total number of (slave) stations : 1
- Mode : Online
- Network range assignment :

StationNo.	M station -> R station						M station <- R station					
	Y			Y			X			X		
	Points	Start	End	Points	Start	End	Points	Start	End	Points	Start	End
1	256	0100	01FF	256	0000	00FF	256	0100	01FF	256	0000	00FF

StationNo.	M station -> R station			M station <- R station			M station -> R station			M station <- R station		
	B			B			W			W		
	Points	Start	End	Points	Start	End	Points	Start	End	Points	Start	End
1							256	0000	00FF	256	0100	01FF

#### • Refresh parameters:

	Link side						PLC side				
	Dev. name	Points	Start	End	Dev. name		Points	Start	End		
Transfer SB	SB	512	0000	01FF	↔	SB	512	0000	01FF		
Transfer S/W	S/W	512	0000	01FF	↔	S/W	512	0000	01FF		
Random cyclic	LB				↔						
Random cyclic	LW				↔						
Transfer1	LB	8192	0000	1FFF	↔	B	8192	0000	1FFF		
Transfer2	LW	8192	0000	1FFF	↔	W	8192	0000	1FFF		
Transfer3	LX	512	0000	01FF	↔	X	512	0000	01FF		
Transfer4	LY	512	0000	01FF	↔	Y	512	0000	01FF		
Transfer5					↔						
Transfer6					↔						

## (2) Operating the utility package

### (a) Initial setting (Refer to Section 5.4)

- CH1, CH2 D/A conversion enable/disable setting..... "Enable"
- CH1 Rate control enable/disable setting..... "Enable"
- CH1 Increase digital limit value..... "100"
- CH1 Decrease digital limit value ..... "30"
- CH2 Warning output setting ..... "Enable"
- CH2 Warning output upper limit value ..... "10000"
- CH2 Warning output lower limit value ..... "3000"

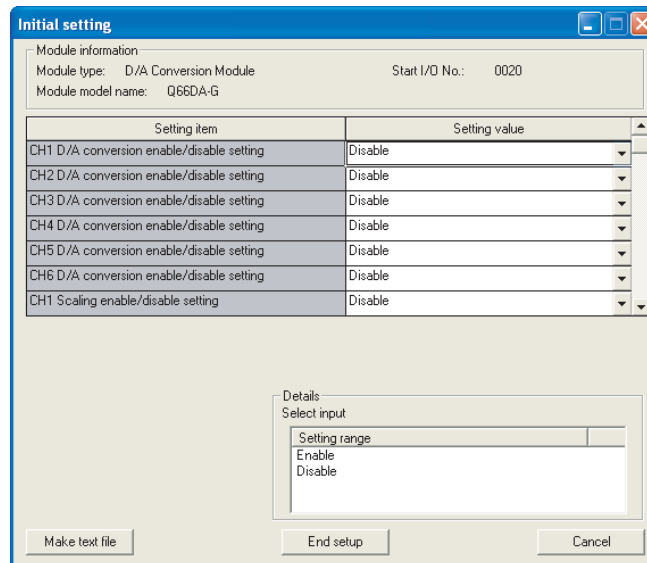

### (b) Auto refresh setting (Refer to Section 5.5)

- CH1, CH2 digital values ..... W11, W12
- Warning output..... W116
- Error code ..... W117

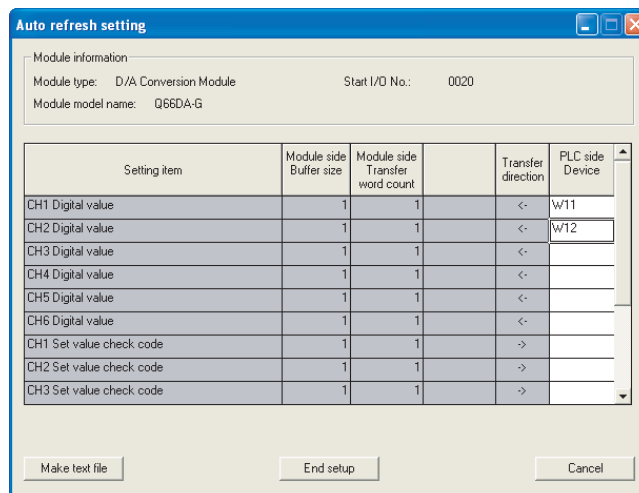

### (c) Write of intelligent function module parameters (Refer to Section 5.3.3)

The intelligent function module parameters are written to the remote I/O station. Perform this operation on the parameter setting module selection screen.

### (3) Programming example

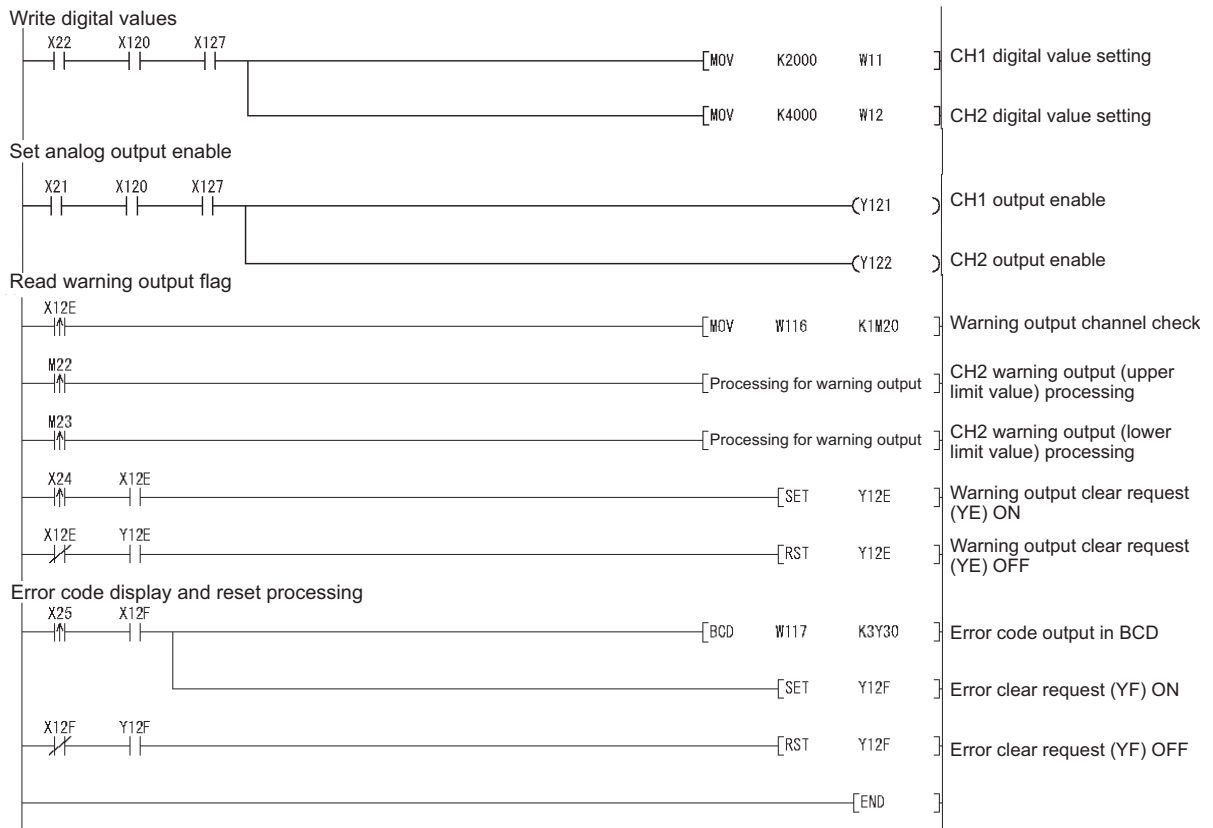

### Point

To write the intelligent function module parameters, set the target remote I/O station from [Online] - [Transfer setup] in GX Developer.

They can be written by:

- Directly connecting GX Developer to the remote I/O station.
- Connecting GX Developer to another device such as a CPU module and passing through the network.

## 6.3.2 Program example without using the utility package

### (1) Operation of GX Developer (Network parameter setting)

- Network type : MNET/H (remote master)
- Head I/O No. : 0000H
- Network No. : 1
- Total number of (slave) stations : 1
- Mode : Online
- Network range assignment :

StationNo.	M station -> R station						M station <- R station					
	Y			Y			X			X		
	Points	Start	End	Points	Start	End	Points	Start	End	Points	Start	End
1	256	0100	01FF	256	0000	00FF	256	0100	01FF	256	0000	00FF

- Refresh parameters :

	Link side					PLC side			
	Dev. name	Points	Start	End		Dev. name	Points	Start	End
Transfer SB	SB	512	0000	01FF	↔	SB	512	0000	01FF
Transfer SW	SW	512	0000	01FF	↔	SW	512	0000	01FF
Random cyclic	LB				↔				
Random cyclic	LW				↔				
Transfer1	LB	8192	0000	1FFF	↔	B	8192	0000	1FFF
Transfer2	LW	8192	0000	1FFF	↔	W	8192	0000	1FFF
Transfer3	LX	512	0000	01FF	↔	X	512	0000	01FF
Transfer4	LY	512	0000	01FF	↔	Y	512	0000	01FF
Transfer5					↔				
Transfer6					↔				

## (2) Programming example

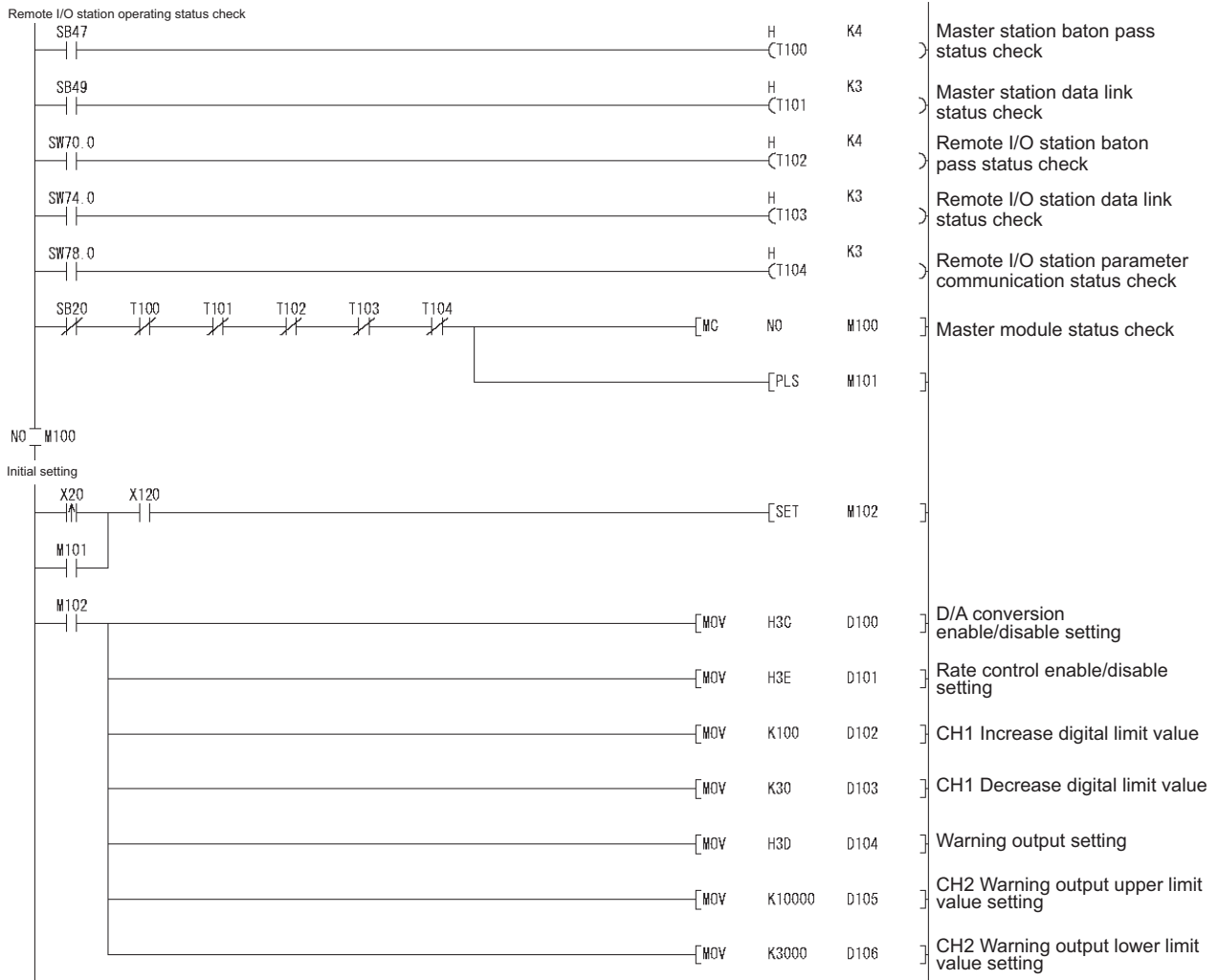

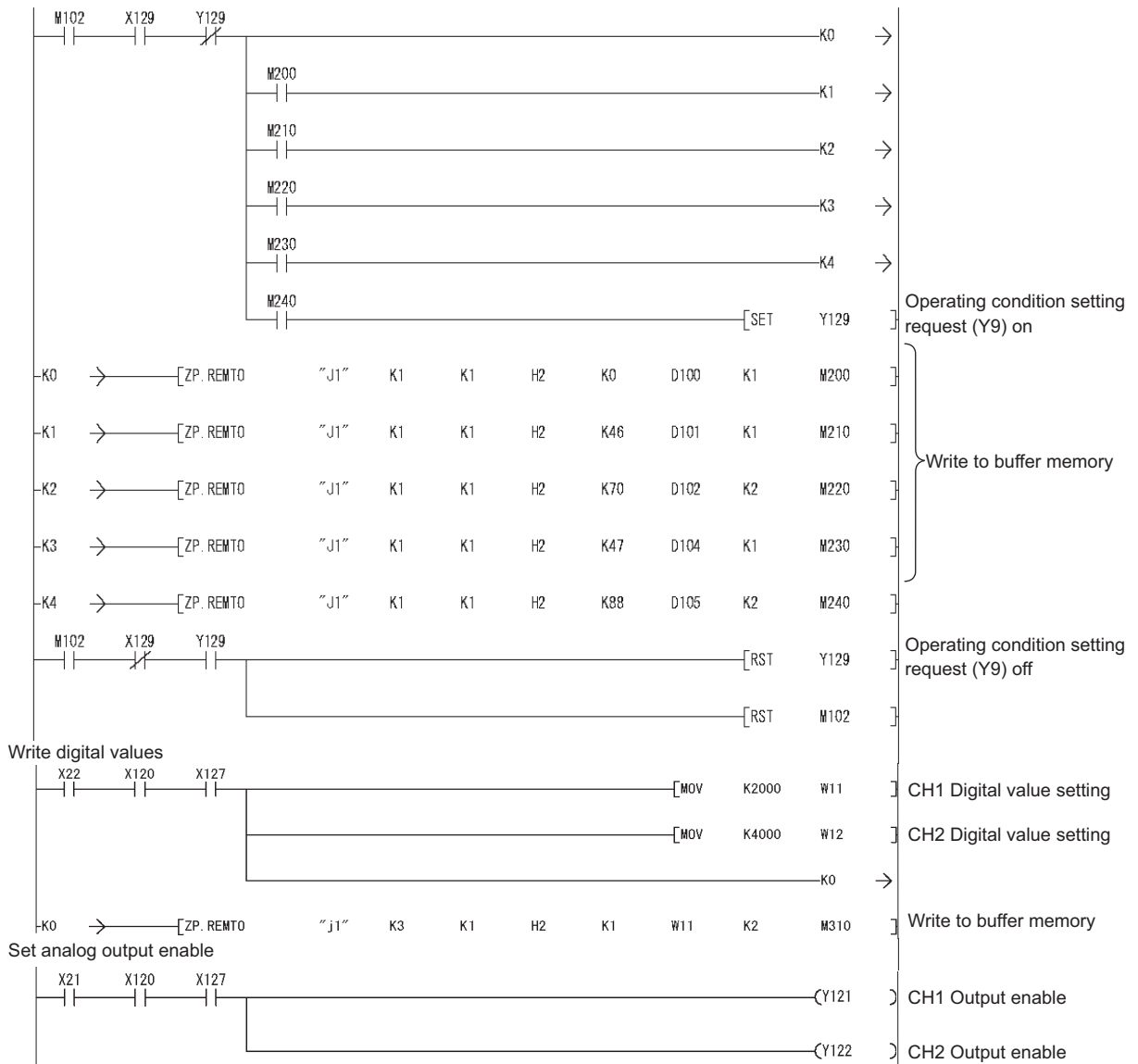

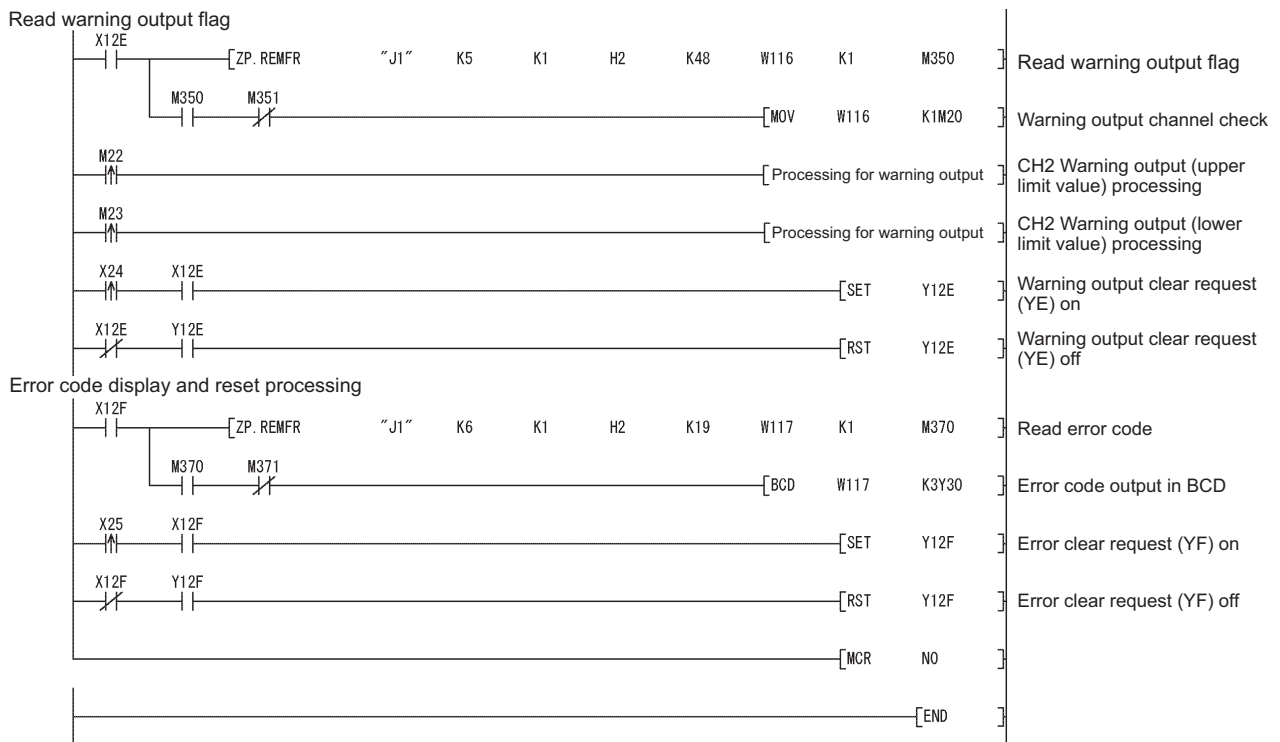



## 7 ONLINE MODULE CHANGE

To perform online module change, read the section about online module change in the QCPU User's Manual (Hardware Design, Maintenance and Inspection).

This chapter describes the specifications of an online module change.

- (1) Perform an online module change by operating GX Developer.
- (2) To ensure ease of offset/gain re-setting, there is a user range save/restoration function that is performed by executing the dedicated instruction or read/write from/to buffer memory.

### ☒ Point

- (1) Perform an online module change after making sure that the system outside the programmable controller will not malfunction.
- (2) To prevent an electric shock and malfunction of operating modules, provide means such as switches for powering off each of the external power supply and external devices connected to the module to be replaced online.
- (3) After the module has failed, data may not be saved properly. Referring to Section 3.4.18, therefore, prerecord the data to be saved (offset/gain values of the industrial shipment settings and user range settings in the buffer memory).
- (4) It is recommended to perform an online module change in the actual system in advance to ensure that it would not affect the other modules by checking the following:
  - Means of cutting off the connection to external devices and its configuration are correct.
  - Switching on/off does not bring any undesirable effect.
- (5) Do not install/remove the module to/from the base unit more than 50 times after the first use of the product. (IEC 61131-2 compliant)  
Failure to do so may cause malfunction.

(Note)

Dedicated instructions cannot be executed during online module change. When execution of a dedicated instruction is needed to save and restore data, execute it using another system<sup>\*1</sup>.

If no other system exists, restore the data by writing them to the buffer memory.

<sup>\*1</sup> If the module is mounted on a remote I/O station, execute save/restoration on another system connected to the main base unit. (Saving and restoration cannot be executed by using a system connected to a remote I/O station.)

## 7.1 Online Module Change Conditions

---

The CPU, MELSECNET/H remote I/O module, Q66DA-G, GX Developer and base unit given below are needed to perform an online module change.

### (1) CPU

The Process CPU or Redundant CPU are required.

For precautions on multiple CPU system configuration, refer to the QCPU User's Manual (Multiple CPU System).

For precautions on redundant system configuration, refer to the QnPRHCPU User's Manual (Redundant System).

### (2) MELSECNET/H remote I/O module

The module of function version D or later is necessary.

### (3) GX Developer

GX Developer of Version 7.10L or later is necessary.

GX Developer of Version 8.18U or later is required to perform an online module change on the remote I/O station.

### (4) Base unit

- 1) When the slim type main base unit (Q3□SB) is used, an online module change cannot be performed.
- 2) When the power supply module unnecessary type extension base unit (Q5□B) is used, online module change cannot be performed for the modules on all the base units connected.

## 7.2 Online Module Change Operations

The following gives the operations performed for an online module change.

CPU operation ○: Executed ✕: Not executed						(User operation)	(Intelligent function module operation)
X/Y refresh	FROM/TO instruction *1	Dedicated instruction	Device test	GX Configurator			
				Initial setting parameter	Monitor/test		
○	○	○	○	✕	✕	(1) Conversion disable Turn off all Y signals that were turned on by a sequence program.*2 ↓ (2) Dismounting of module Operate GX Developer to start an online module change ↓ Click the [Execution] button of GX Developer to make the module dismountable. ↓ Dismount the corresponding module. ↓ (3) Mounting of new module Mount a new module.*5 ↓ After mounting the module, click the [Execution] button of GX Developer. ↓ Operation check before control start (4) Operation check Click the [Cancel] button of GX Developer to leave the online mode ↓ Conduct an operation test on the new module using "Device test" of GX Developer or "Monitor/test" of GX Configurator. Perform user range restoration processing by write to buffer memory at this point. ↓ Operation check completed (5) Resumption of control Operate GX Developer to resume the online module change mode, and click the [Execution] button to resume control.	Module is operating as usual. ↓ Module stops operating. RUN LED turns off. Conversion disabled. Analog output is 0V/0mA. ↓ *3 X/Y refresh resumes and the module starts. RUN LED turns on. Default operation (X0 remains off) (When there are initial setting parameters, operation is performed according to the initial setting parameters at this point.) ↓ Module operates according to test operation *4 ↓ X0 (Module READY) turns on. ↓ Start is made when X0 turns from off to on. Operation is performed according to the initial setting sequence.*4
✕	✕	✕	✕	✕	✕		
○	✕	✕	✕	○	✕		
○	✕	✕	○	✕	○		
○	○	○	○	✕	○		

\*1 Access to the intelligent function module device (U□\G□) is included.

\*2 Operating the intelligent function module switches (\*3) starts the module and resumes X/Y refresh. When there are initial setting parameters, operation is performed according to the initial setting parameters.

Hence, if the Y signals are not turned off, analog outputs will be provided at this point. Therefore, always turn off the Y signals that were turned on by the sequence program.

\*4 In the absence of the operation marked \*4, the operation of the intelligent function module is the operation performed prior to that.

\*5 If a module in either of 4 to 20mA (Extended mode) or 1 to 5V (Extended mode) range is replaced online with a module that does not support the extended mode range, an intelligent function module switch error occurs and the extended mode range is not available.

## 7.3 Online Module Change Procedure

There are the following online module change procedures depending on whether the user range setting has been made or not, whether the initial setting of GX Configurator-DA has been made or not, and whether the other system exists or not.

Range setting	Initial setting	Other system	Reference section
Industrial shipment setting	GX Configurator-DA	-	Section 7.3.1
Industrial shipment setting	Sequence program	-	Section 7.3.2
User range setting	GX Configurator-DA	Present	Section 7.3.3
User range setting	GX Configurator-DA	Absent	Section 7.3.4
User range setting	Sequence program	Present	Section 7.3.5
User range setting	Sequence program	Absent	Section 7.3.6

### 7.3.1 When industrial shipment setting is used and initial setting was made with GX Configurator-DA

#### (1) Conversion disable

(a) Take the following steps to disable the conversion:

- 1) Set D/A conversion enable/disable setting (Un\G0) to All channel conversion disable (3FH).
- 2) Turn Operating condition setting request (Y9) from off to on to stop the conversion.
- 3) Operating condition setting completed flag (X9) turns off from on.
- 4) Check that the conversion is stopped by seeing the actual analog output value.
- 5) Turn Operating condition setting request (Y9) from on to off.

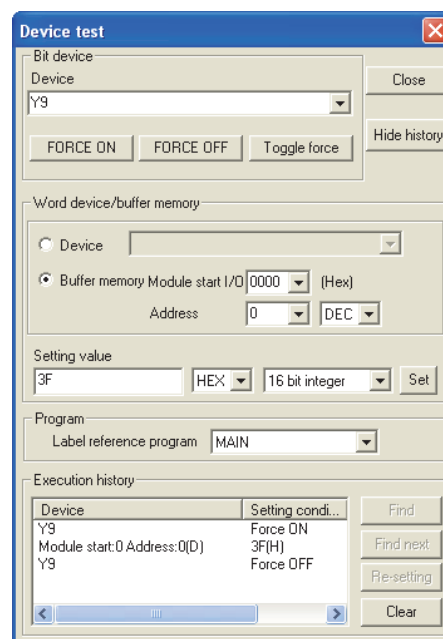

## (2) Dismounting of module

- (a) After choosing [Diagnostics] - [Online module change] in GX Developer to enter the "Online module change" mode, double-click the module to be changed online to display the "Online module change" dialog box.

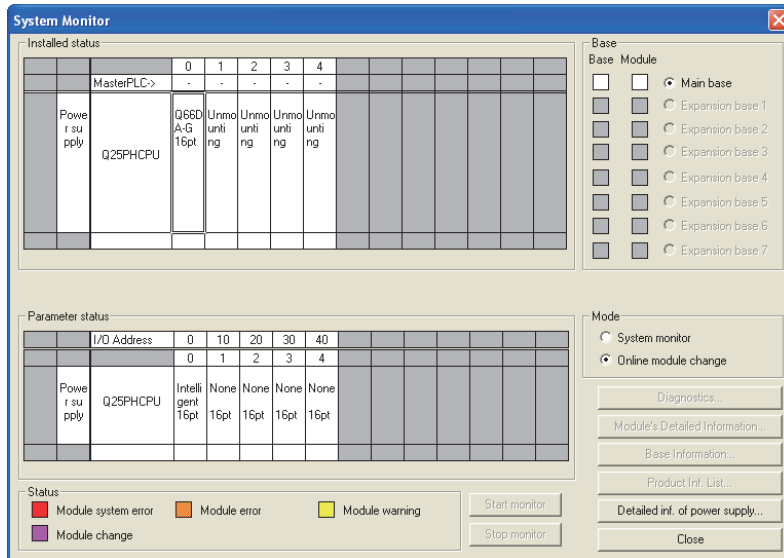

- (b) Click the "Execution" button to enable a module change.

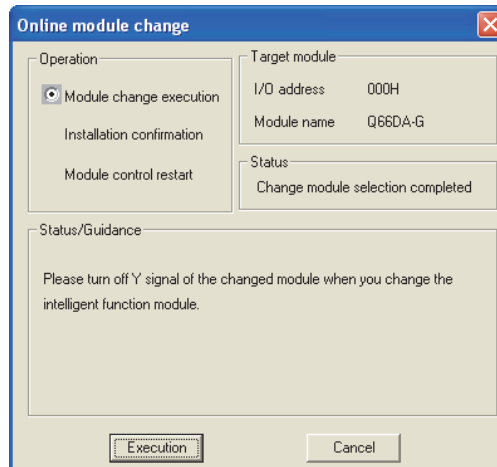

If the following error message appears, click the [OK] button, dismount the module as-is, and mount a new module.



- (c) After confirming that the "RUN" LED of the module has turned off, remove the connector and dismount the module.

## ☒ Point

Always perform the dismounting procedure. If mounting confirmation is made without the module being dismounted, the module will not start properly and the "RUN" LED will not be lit.

### (3) Mounting of new module

- (a) Mount a new module to the same slot and install the connector.
- (b) After mounting the module, click the [Execution] button and make sure that the "RUN" LED is lit. Module READY (X0) remains off.

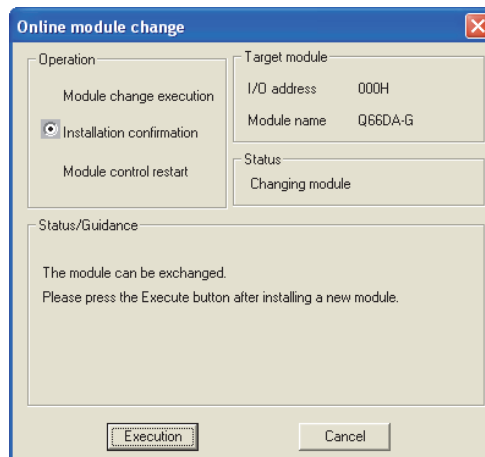

### (4) Operation check

- (a) To make an operation check, click the [Cancel] button to cancel control resumption.

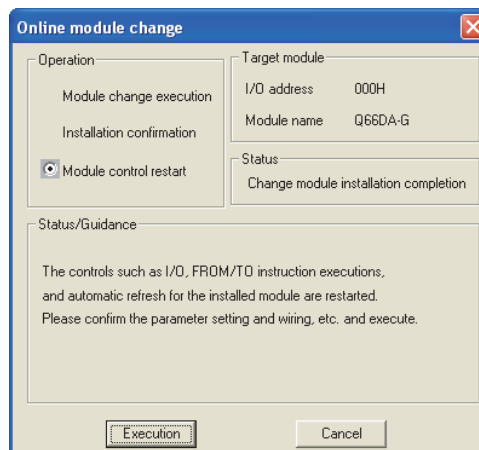

(b) Click the [OK] button to leave the "Online module change" mode.

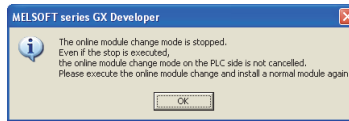

(c) Click the [Close] button to close the System Monitor dialog box.

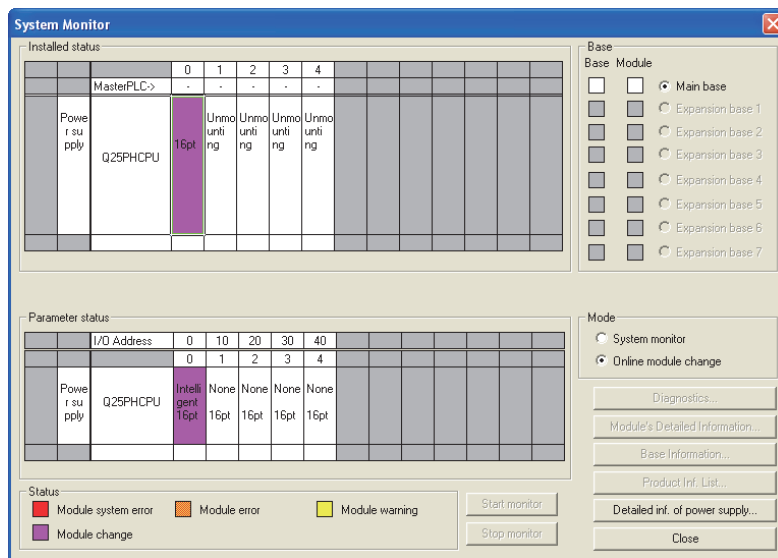

(d) Set digital values to CH□ Digital value (Un\G1 to Un\G6) and turn Operating condition setting request (Y9) from off to on. Turn on Output enable/disable flag (Y1 to Y6) of the used channel to check whether proper conversion has been made or not.  
(Be careful since corresponding analog signals will be actually output.)

## (5) Resumption of control

(a) After choosing [Diagnostics] - [Online module change] in GX Developer to display the "Online module change" screen again, click the [Execution] button to resume control. Module READY (X0) will be turned on.

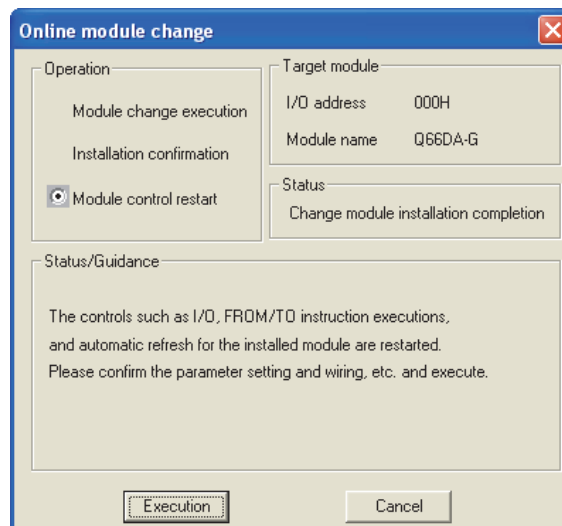

(b) A message, "Online module change completed." appears.





## 7.3.2 When industrial shipment setting is used and initial setting was made with sequence program

### (1) Conversion disable

- (a) Take the following steps to disable the conversion:
- 1) Set D/A conversion enable/disable setting (Un\G0) to All channel conversion disable (3FH).
  - 2) Turn Operating condition setting request (Y9) from off to on to stop the conversion.
  - 3) Operating condition setting completed flag (X9) turns off from on.
  - 4) Check that the conversion is stopped by seeing the actual analog output value.
  - 5) Turn Operating condition setting request (Y9) from on to off.

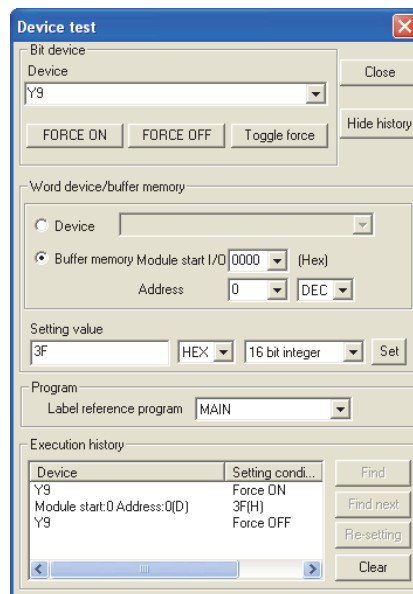

## (2) Dismounting of module

- (a) After choosing [Diagnostics] - [Online module change] in GX Developer to enter the "Online module change" mode, double-click the module to be changed online to display the "Online module change" dialog box.

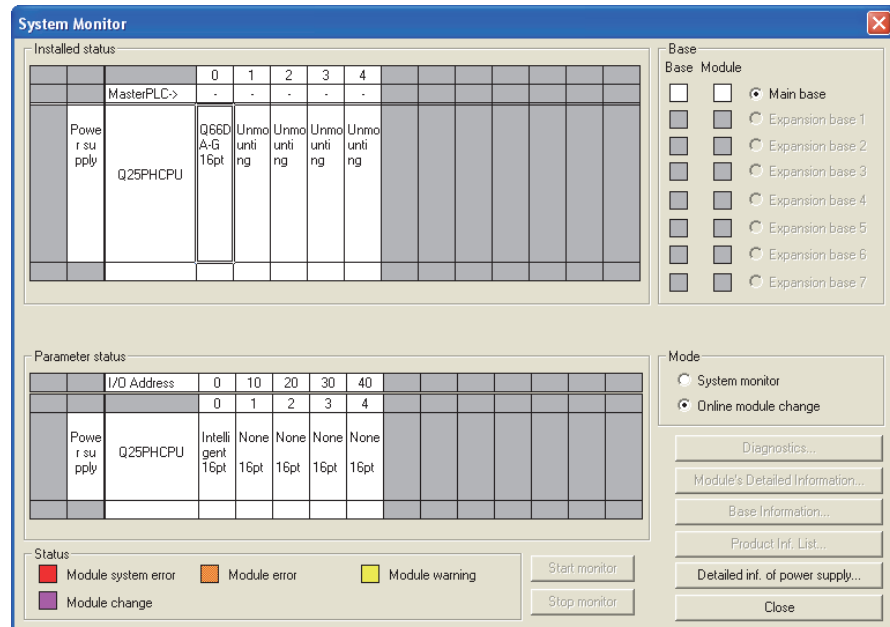

- (b) Click the "Execution" button to enable a module change.

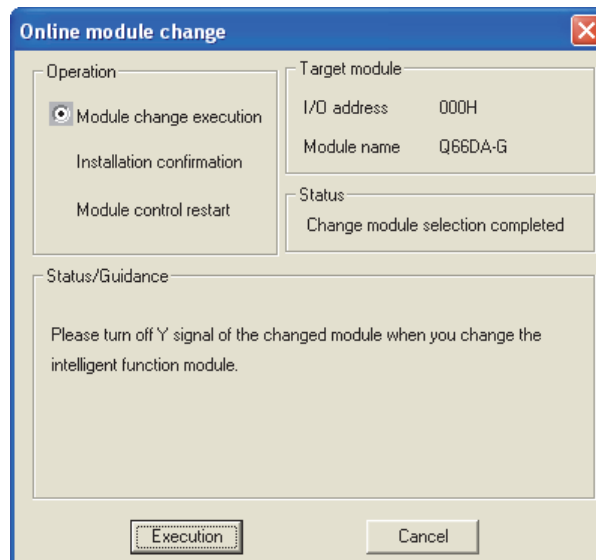

If the following error message appears, click the [OK] button, dismount the module as-is, and mount a new module.

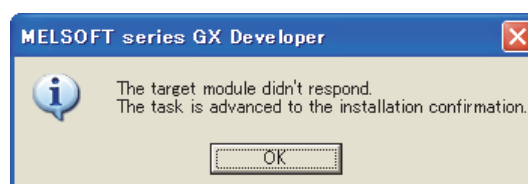

- (c) After confirming that the "RUN" LED of the module has turned off, remove the connector and dismount the module.

## ☒ Point

Always perform the dismounting procedure. If mounting confirmation is made without the module being dismounted, the module will not start properly and the "RUN" LED will not be lit.

### (3) Mounting of new module

- (a) Mount a new module to the same slot and install the connector.
- (b) After mounting the module, click the [Execution] button and make sure that the "RUN" LED is lit. Module READY (X0) remains off.

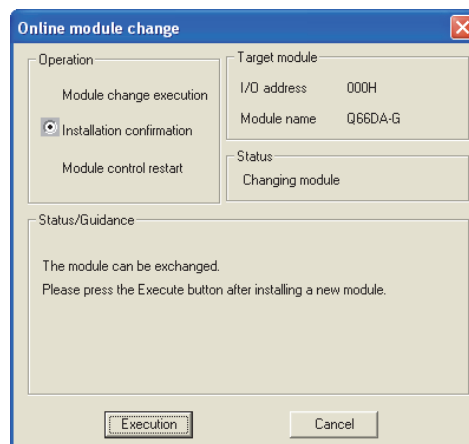

## (4) Operation check

- (a) To make an operation check, click the [Cancel] button to cancel control resumption.

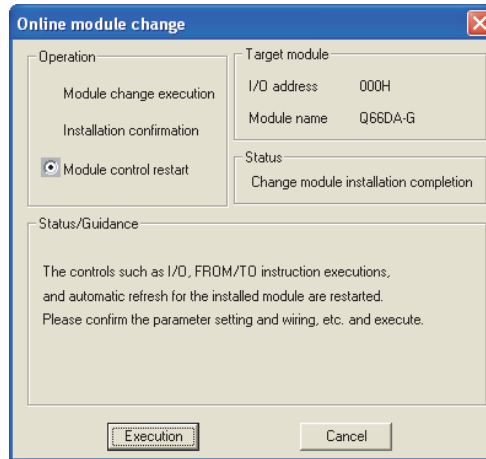

- (b) Click the [OK] button to leave the "Online module change" mode.

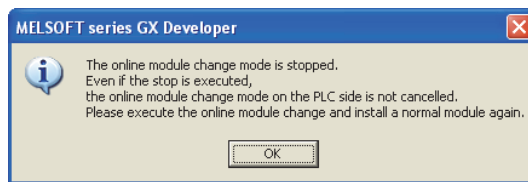

- (c) Click the [Close] button to close the System Monitor dialog box.

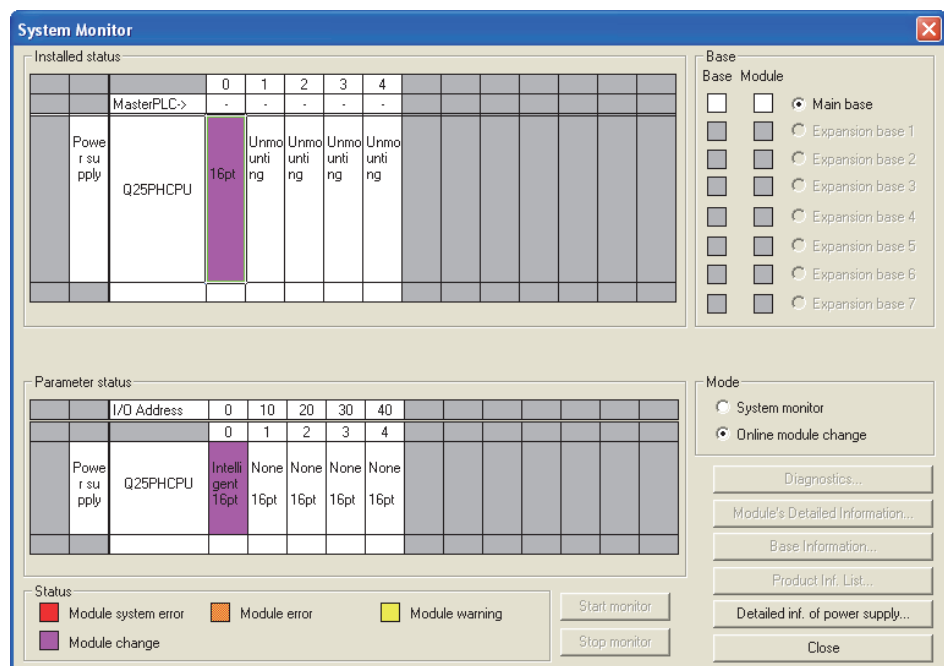

- (d) Enable the channels to be used in D/A conversion enable/disable setting (Un\G0). Set digital values in CH□ Digital value (Un\G1 to Un\G6) and turn Operating condition setting request (Y9) from off to on. Turn on Output enable/disable flag (Y1 to Y6) of the used channel to check whether proper conversion has been made or not.  
(Be careful since corresponding analog signals will be actually output.)

- (e) Since the new module is in a default status, it must be initialized by a sequence program after control resumption.  
Before performing initialization, check whether the contents of the initialization program are correct or not.

### 1) Normal system configuration

The sequence program should perform initialization on the leading edge of Module READY (X9) of the Q66DA-G.

When control resumption is executed, Module READY (X0) turns on and initialization is performed. (If the sequence program performs initialization only for one scan after entering the RUN status, initialization is not performed.)

### 2) When used on remote I/O network

Insert a user device that will execute initialization at any timing (initialization request signal) into the sequence program. After control resumption, turn on the initialization request signal to perform initialization. (If the sequence program performs initialization only one scan after a data link start of the remote I/O network, initialization is not performed.)

## (5) Resumption of control

- (a) After choosing [Diagnostics] - [Online module change] in GX Developer to display the "Online module change" screen again, click the [Execution] button to resume control. Module READY (X0) will be turned on.

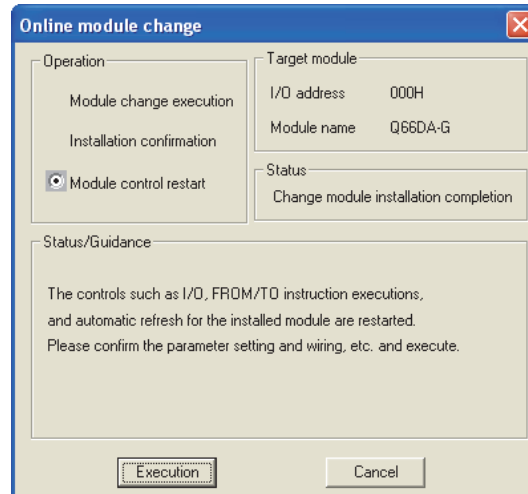

- (b) A message, "Online module change completed" appears.



## 7.3.3 When user range setting is used and initial setting was made with GX Configurator-DA (other system is available)

### (1) Conversion disable

- (a) Take the following steps to disable the conversion:
- 1) Set D/A conversion enable/disable setting (Un\G0) to All channel conversion disable (3FH).
  - 2) Turn Operating condition setting request (Y9) from off to on to stop the conversion.
  - 3) Operating condition setting completed flag (X9) turns off from on.
  - 4) Check that the conversion is stopped by seeing the actual analog output value.
  - 5) Turn Operating condition setting request (Y9) from on to off.

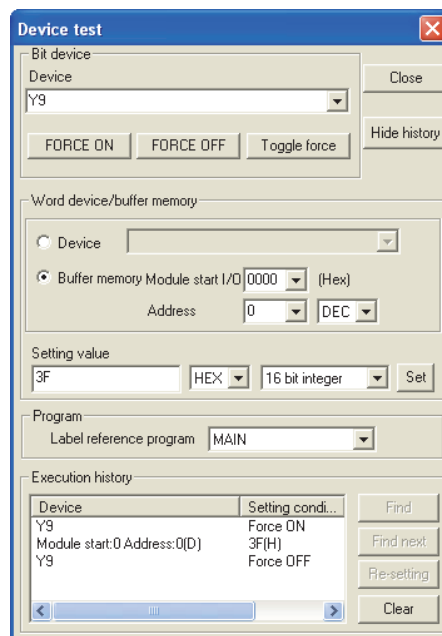

## (2) Dismounting of module

- (a) After choosing [Diagnostics] - [Online module change] in GX Developer to enter the "Online module change" mode, double-click the module to be changed online to display the "Online module change" dialog box.

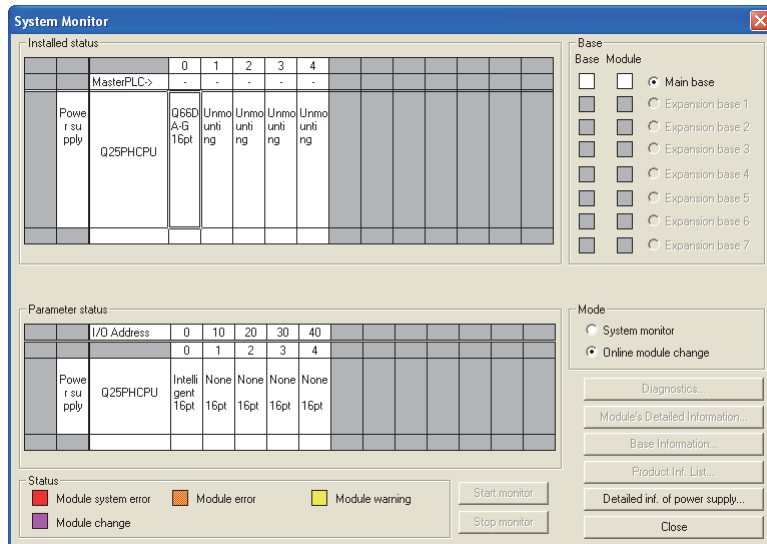

- (b) Click the "Execution" button to enable a module change.

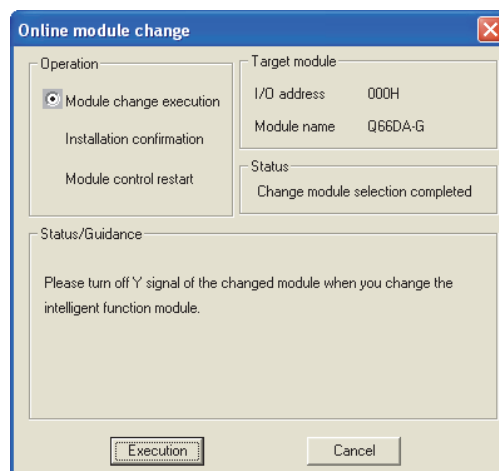

If the following error message appears, the user range data cannot be saved. Click the [OK] button, and perform the operation in Section 7.3.4 (2) (c) and later.

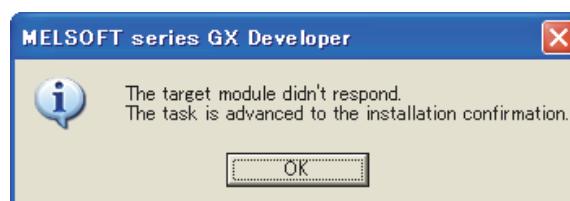



- (c) After confirming that the "RUN" LED of the module has turned off, remove the connector and dismount the module.

## ☒ Point

Always perform the dismounting procedure. If mounting confirmation is made without the module being dismounted, the module will not start properly and the "RUN" LED will not be lit.

### (3) Mounting of new module

- (a) Mount the dismounted module and new module to the other system.
- (b) Using the G(P).OGLOAD instruction, save the user set values to the CPU device. Refer to Appendix 1.2 for the G(P).OGLOAD instruction.
- (c) Using the G(P).OGSTOR instruction, restore the user set values to the module. Refer to Appendix 1.3 for the G(P).OGSTOR instruction.
- (d) Dismount the new module from the other system, mount it to the slot from where the old module was dismounted in the original system, and install the connector.
- (e) After mounting the module, click the [Execution] button and make sure that the "RUN" LED is lit. Module READY (X0) remains off.

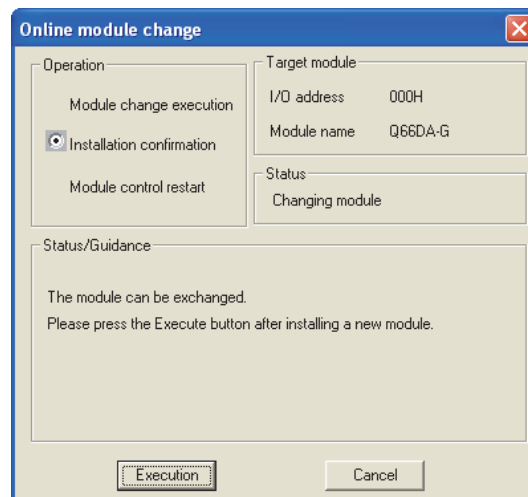

## (4) Operation check

(a) To make an operation check, click the [Cancel] button to cancel control resumption.

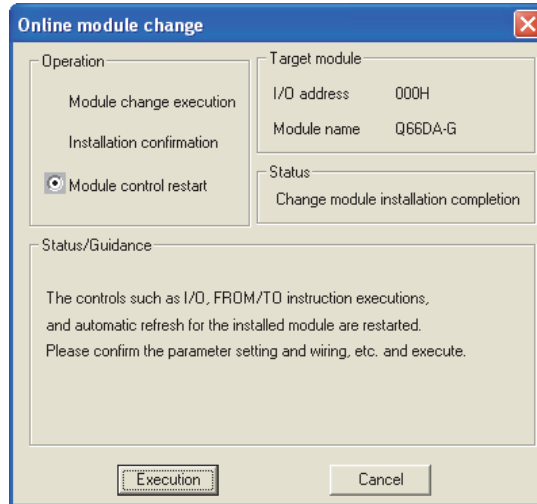

(b) Click the [OK] button to leave the "Online module change" mode.

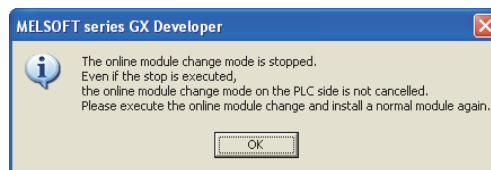

(c) Click the [Close] button to close the System Monitor dialog box.

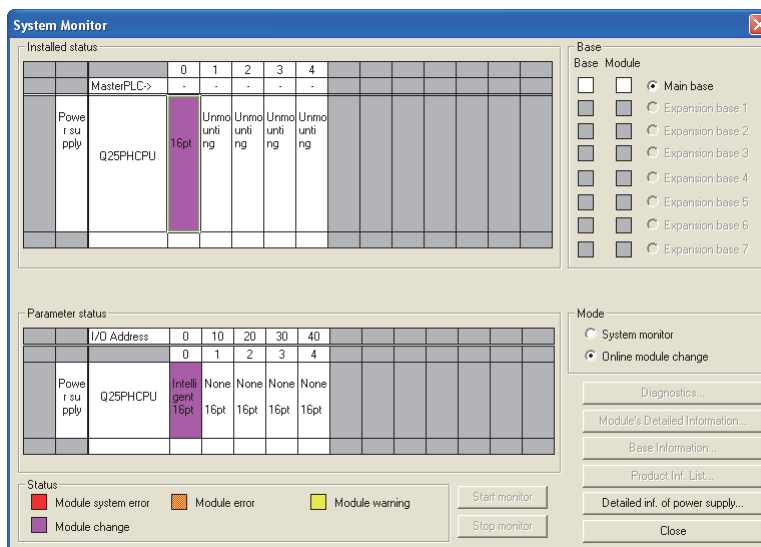

- (d) Set digital values to CH□ Digital value (Un\G1 to Un\G6) and turn Operating condition setting request (Y9) from off to on. Turn on CH□ Output enable/disable flag (Y1 to Y6) of the used channel to check whether proper conversion has been made or not.

(Be careful since corresponding analog signals will be actually output.)

## (5) Resumption of control

- (a) After choosing [Diagnostics] - [Online module change] in GX Developer to redisplay the "Online module change" dialog box, click the [Execution] button to resume control. Module READY (X0) will be turned on.

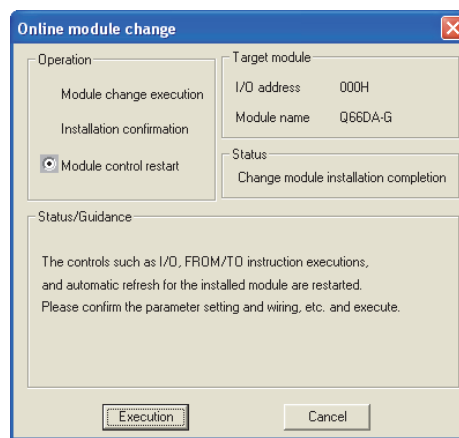

- (b) A message, "Online module change completed" appears.



## 7.3.4 When user range setting is used and initial setting was made with GX Configurator-DA (other system is unavailable)

### (1) Conversion disable

- (a) In the Operating condition setting window of GX Configurator-DA, set "Disable" in the Setting value field of CH  D/A conversion enable/disable setting, and click the **Execute test** button.

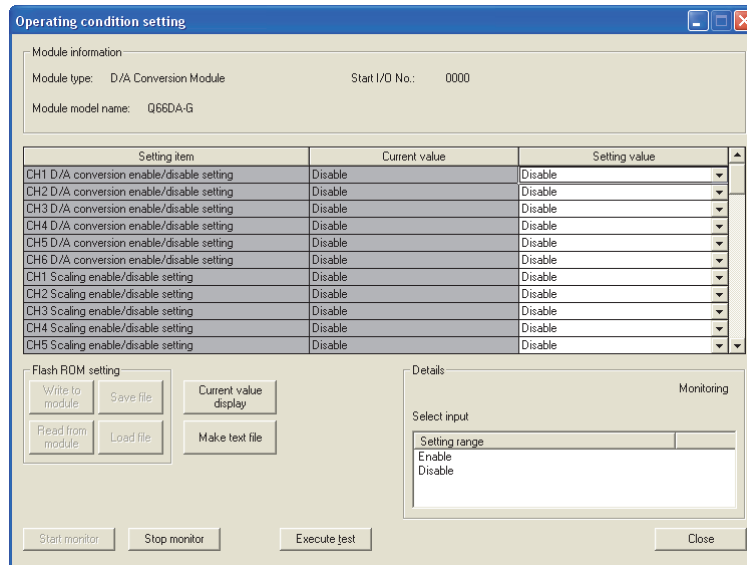

- (b) After making sure that the indication in the Current value field of CH  D/A conversion enable/disable setting is "Disable", change the Setting value field of Operating condition setting request to "Setting request", and click the **Execute test** button to stop conversion.

Confirm that conversion has stopped with the actual analog output value.

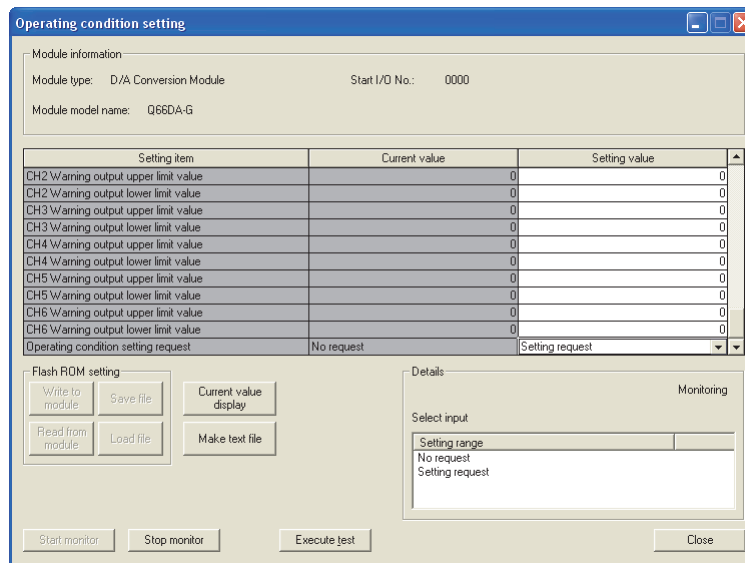

- (c) If the saved buffer memory contents are not yet prerecorded, record them in the following procedure.
- 1) Display the pass data screen of GX Configurator-DA.
  - 2) Select the user range used for Pass data classification setting, and make a pass data read request. (Refer to Section 5.6.4.)
  - 3) Compare the current values of the industrial shipment settings and user range settings offset/gain values with those of the range reference table. Refer to Section 7.3.6 for the range reference table.
  - 4) If the values are proper, record the offset/gain values of Pass data classification setting, Industrial shipment settings and User range settings offset/gain value.

## ☒ Point

If the buffer memory values compared with the reference table are not proper, save and restoration of the user range cannot be executed.  
 Before executing module control resumption, make offset/gain setting in the GX Configurator-DA. (Refer to Section 5.6.2)  
 Note that if module control is resumed without offset/gain setting being made, operation will be performed with the default values.

## (2) Dismounting of module

- (a) After choosing [Diagnostic] - [Online module change] in GX Developer to enter the "Online module change" mode, double-click the module to be changed online to display the "Online module change" dialog box.

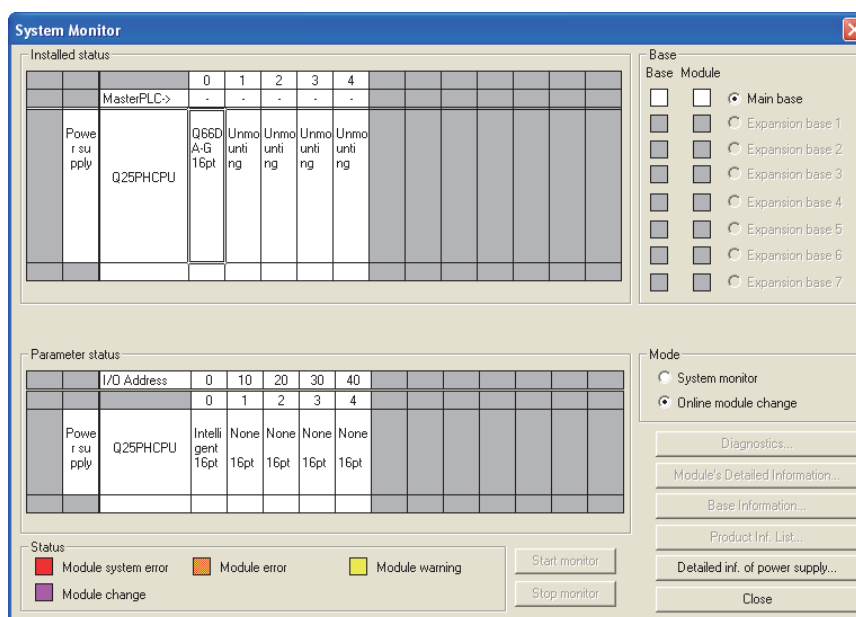

(b) Click the "Execution" button to enable a module change.

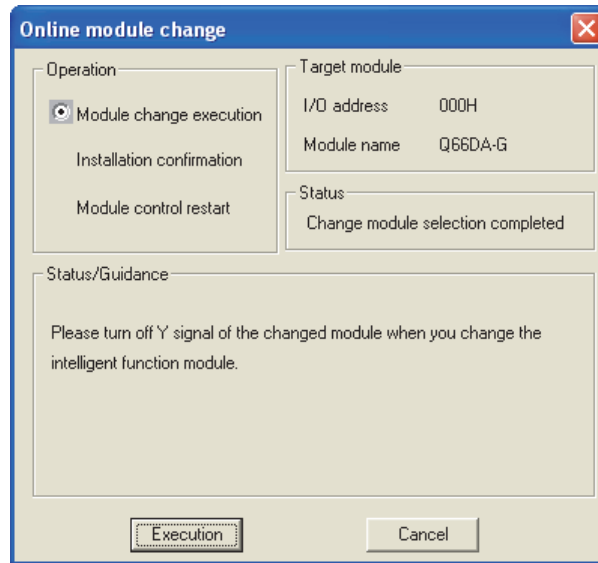

If the following error message appears, the user range data cannot be saved. Click the [OK] button, and perform the operation in This Section (2) (c) and later.

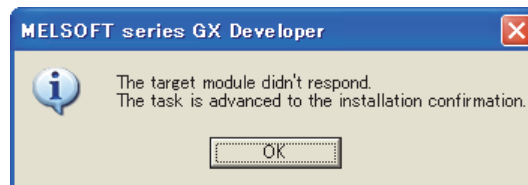

(c) After confirming that the "RUN" LED of the module has turned off, remove the connector and dismount the module.

## ☒ Point

Always perform the dismounting procedure. If mounting confirmation is made without the module being dismounted, the module will not start properly and the "RUN" LED will not be lit.

### (3) Mounting of new module

- (a) Mount a new module to the same slot and install the connector.
- (b) After mounting the module, click the [Execution] button and make sure that the "RUN" LED is lit. Module READY (X0) remains off.

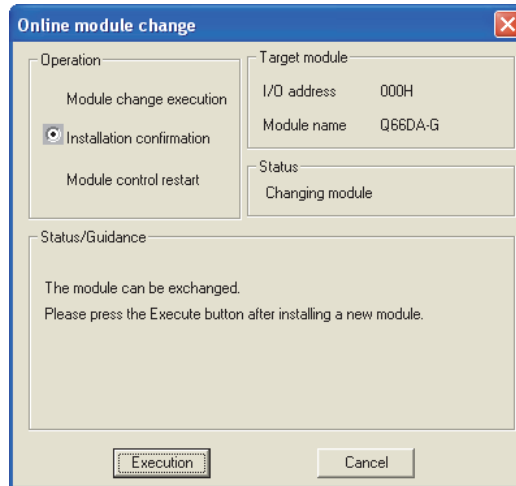

### (4) Operation check

- (a) To make an operation check, click the [Cancel] button to cancel control resumption.

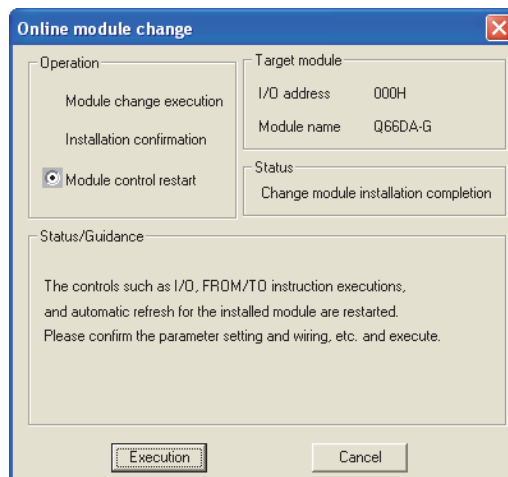

- (b) Click the [OK] button to leave the "Online module change" mode.

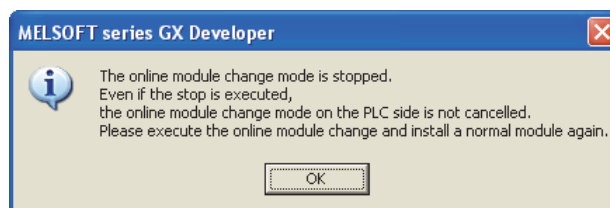

(c) Click the [Close] button to close the System Monitor dialog box.

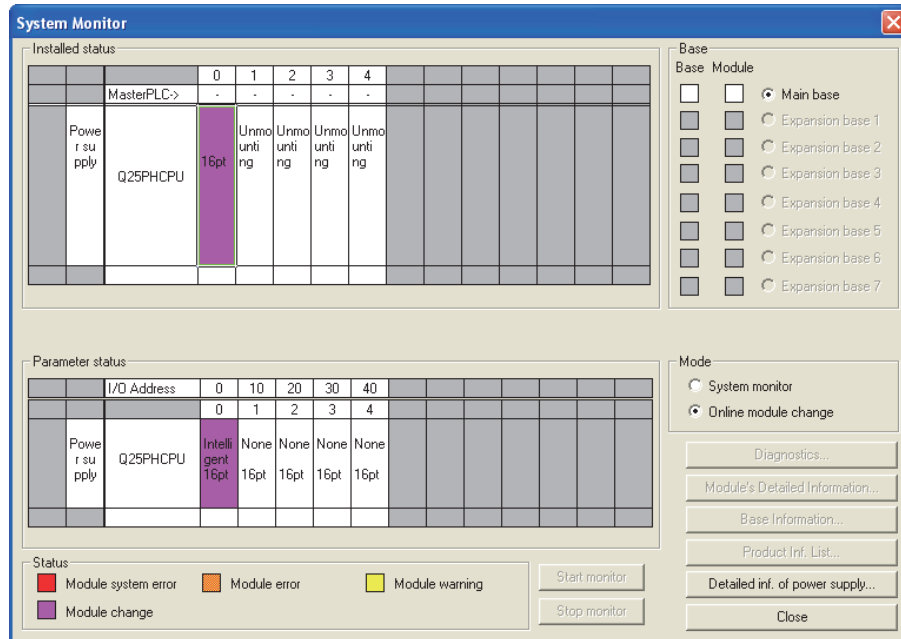

- (d) On the pass data screen of GX Configurator-DA, set the prerecorded values and make a pass data write request. (Refer to Section 5.6.4.)
- (e) In the Operating condition setting window of GX Configurator-DA, set "Enable" in the Setting value field of CH□ D/A conversion enable/disable setting for each channel used.
- (f) In the Monitor/Test window of GX Configurator-DA, set a value in the setting value field of CH□ Digital value of the used channel, and click the [Execute test] button.

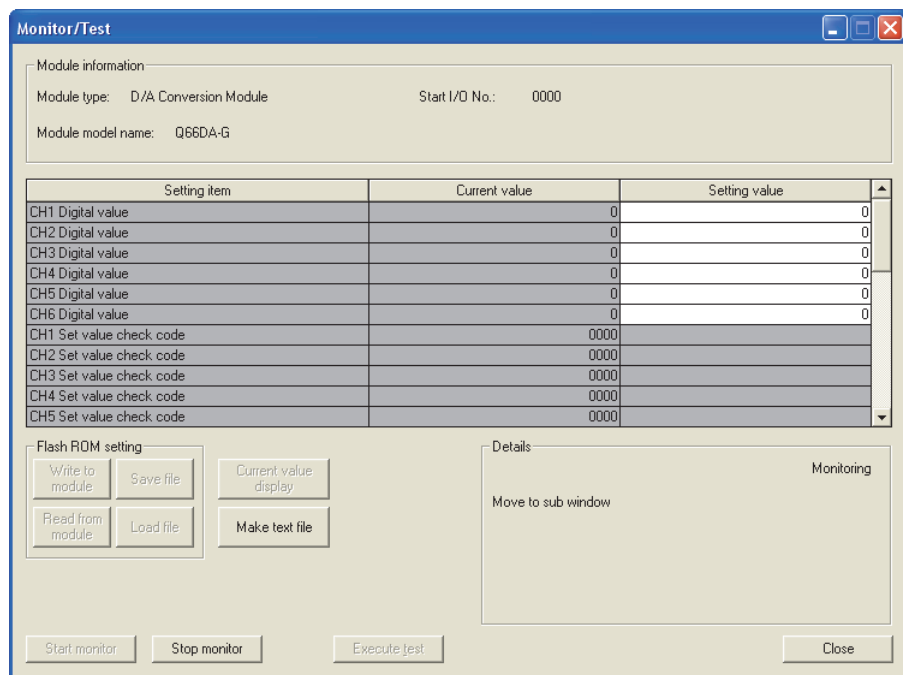



- (g) Turn on Output enable/disable flag (Y1 to Y6) of the used channel and check whether proper conversion has been made or not.  
(Be careful since corresponding analog signals will be actually output.)

## (5) Resumption of control

- (a) After choosing [Diagnostics] - [Online module change] in GX Developer to redisplay the "Online module change" dialog box, click the [Execution] button to resume control. Module READY (X0) will be turned on.

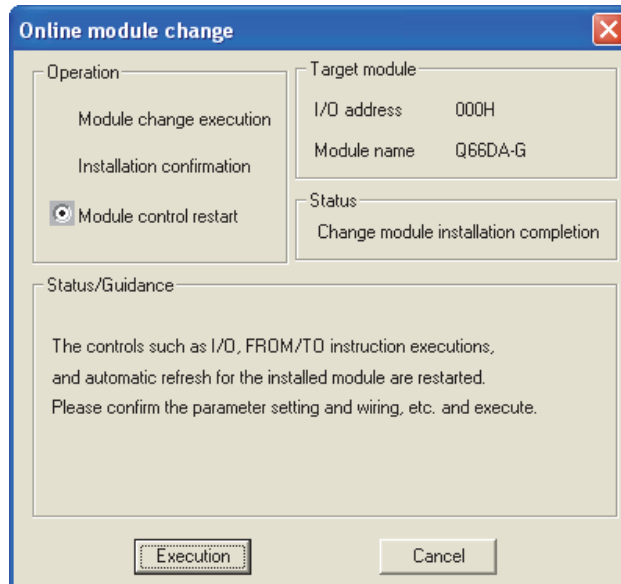

- (b) A message, "Online module change completed" appears.



## 7.3.5 When user range setting is used and initial setting was made with sequence program (other system is available)

### (1) Conversion disable

(a) Take the following steps to disable the conversion:

- 1) Set D/A conversion enable/disable setting (Un\G0) to All channel conversion disable (3FH).
- 2) Turn Operating condition setting request (Y9) from off to on to stop the conversion.
- 3) Operating condition setting completed flag (X9) turns off from on.
- 4) Check that the conversion is stopped by seeing the actual analog output value.
- 5) Turn Operating condition setting request (Y9) from on to off.

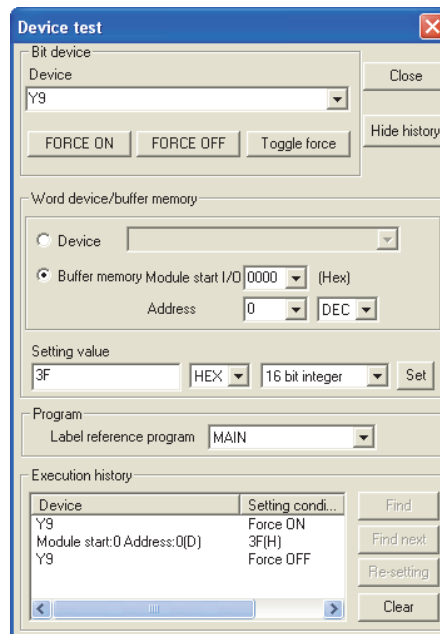

## (2) Dismounting of module

- (a) After choosing [Diagnostics] - [Online module change] in GX Developer to enter the "Online module change" mode, double-click the module to be changed online to display the "Online module change" dialog box.

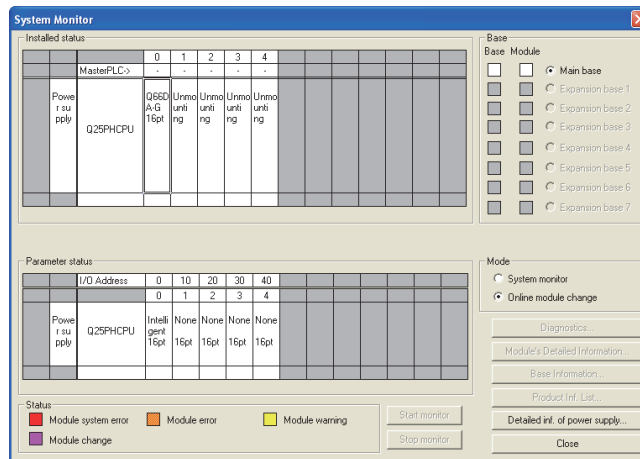

- (b) Click the "Execution" button to enable a module change.

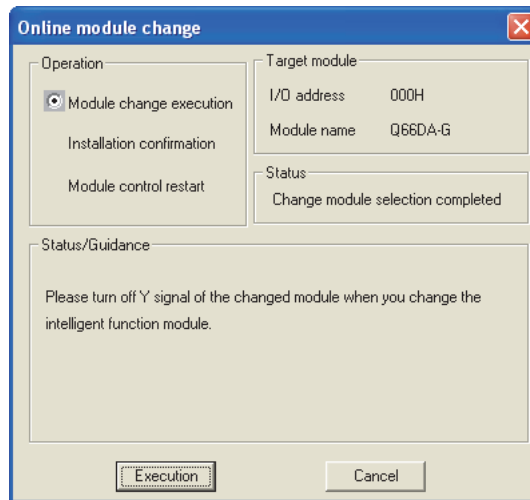

If the following error message appears, the user range data cannot be saved. Click the [OK] button, and perform the operation in Section 7.3.6 (2) (c) and later.

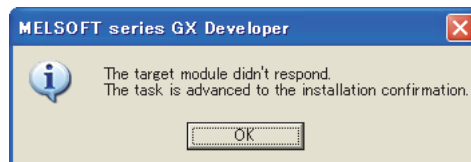

- (c) After confirming that the "RUN" LED of the module has turned off, remove the connector and dismount the module.

## ☒ Point

Always perform the dismounting procedure. If mounting confirmation is made without the module being dismounted, the module will not start properly and the "RUN" LED will not be lit.

### (3) Mounting of new module

- (a) Mount the dismounted module and new module to the other system.
- (b) Using the G(P).OGLOAD instruction, save the user set values to the CPU device. Refer to Appendix 1.2 for the G(P).OGLOAD instruction.
- (c) Using the G(P).OGSTOR instruction, restore the user set values to the module. Refer to Appendix 1.3 for the G(P).OGSTOR instruction.
- (d) Dismount the new module from the other system, mount it to the slot from where the old module was dismounted in the original system, and install the connector.
- (e) After mounting the module, click the [Execution] button and make sure that the "RUN" LED is lit. Module READY (X0) remains off.

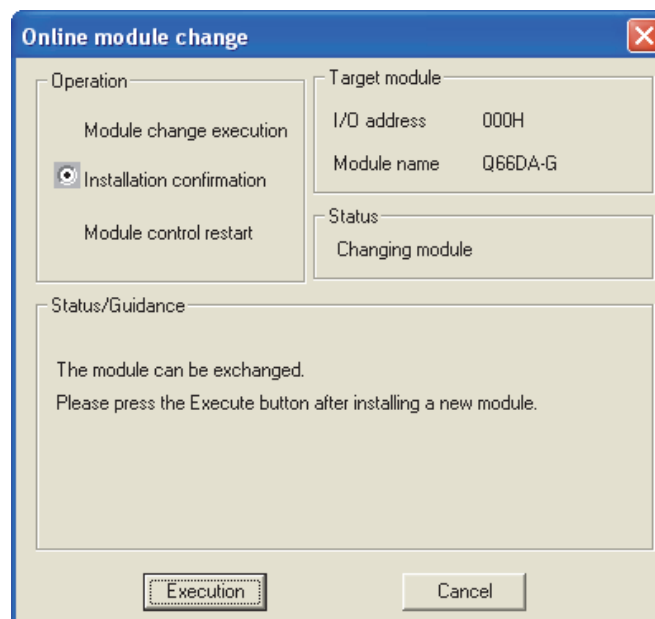

## (4) Operation check

- (a) To make an operation check, click the [Cancel] button to cancel control resumption.

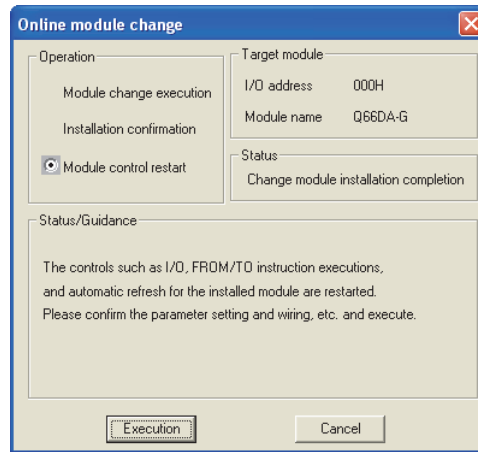

- (b) Click the [OK] button to leave the "Online module change" mode.

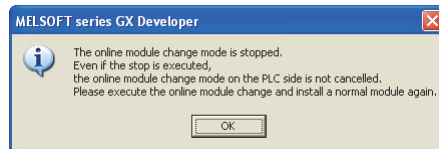

- (c) Click the [Close] button to close the System Monitor dialog box.

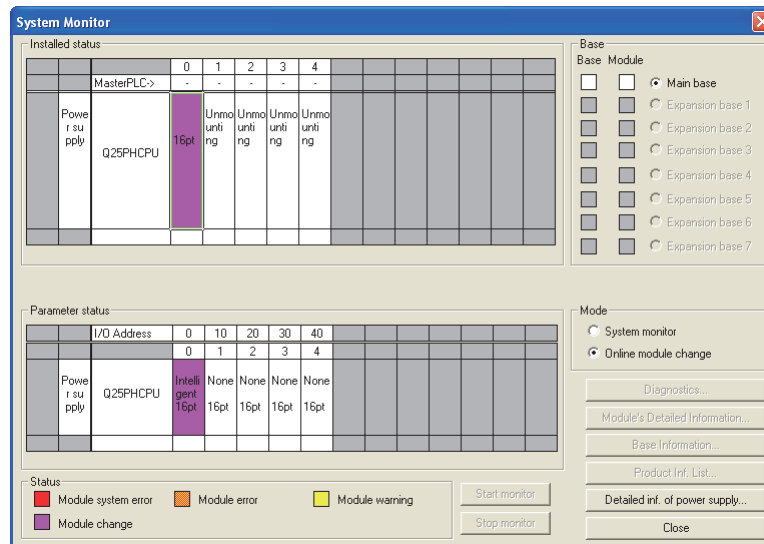

- (d) Enable the channels to be used in D/A conversion enable/disable setting (Un\G0). Set digital values to CH□ Digital value (Un\G1 to Un\G6) and turn Operating condition setting request (Y9) from off to on. Turn on Output enable/disable flag (Y1 to Y6) of the used channel to check whether proper conversion has been made or not.  
(Be careful since corresponding analog signals will be actually output.)

- (e) Since the new module is in the default status, it must be initialized by a sequence program after control resumption.

Before performing initialization, check whether the contents of the initialization program are correct or not.

### 1) Normal system configuration

The sequence program should perform initialization on the leading edge of Module READY (X9) of the Q66DA-G.

When control resumption is executed, Module READY (X0) turns on and initialization is performed. (If the sequence program performs initialization only for one scan after entering the RUN status, initialization is not performed.)

### 2) When used on remote I/O network

Insert a user device that will execute initialization at any timing (initialization request signal) into the sequence program. After control resumption, turn on the initialization request signal to perform initialization. (If the sequence program performs initialization only one scan after a data link start of the remote I/O network, initialization is not performed.)

## (5) Resumption of control

- (a) After choosing [Diagnostics] - [Online module change] in GX Developer to redisplay the "Online module change" dialog box, click the [Execution] button to resume control. Module READY (X0) will be turned on.

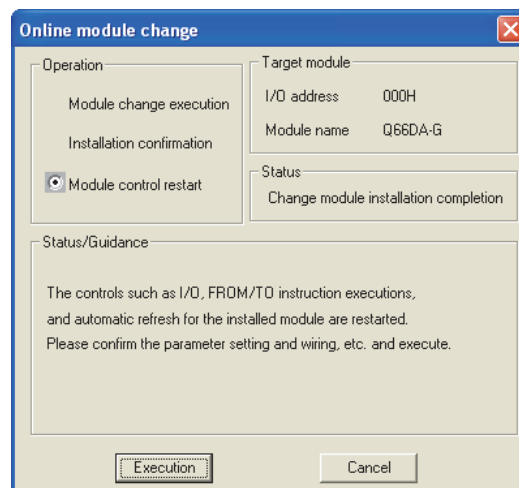

- (b) A message, "Online module change completed" appears.



## 7.3.6 When user range setting is used and initial setting was made with sequence program (other system is unavailable)

### (1) Conversion disable

- (a) Take the following steps to disable the conversion:
- 1) Set D/A conversion enable/disable setting (Un\G0) to All channel conversion disable (3FH).
  - 2) Turn Operating condition setting request (Y9) from off to on to stop the conversion.
  - 3) Operating condition setting completed flag (X9) turns off from on.
  - 4) Check that the conversion is stopped by seeing the actual analog output value.
  - 5) Turn Operating condition setting request (Y9) from on to off.

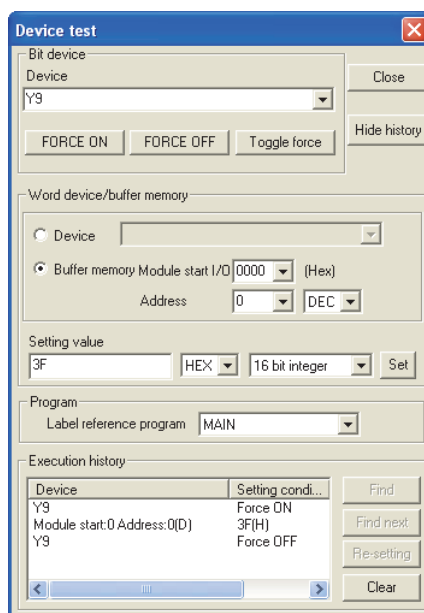

- (b) If the saved buffer memory contents are not yet prerecorded, record them in the following procedure.
- 1) Make Pass data classification setting (Un\G200).
  - 2) Turn Operating condition setting request (Y9) from off to on.
  - 3) Compare the offset/gain values of Industrial shipment settings and User range settings (Un\G214 to Un\G225) with the range reference table. Refer to Section 7.4 for the range reference table.
  - 4) If the values are proper, record the offset/gain values of Pass data classification setting, Industrial shipment settings, and User range settings.

---

## ☒ Point

If the buffer memory values compared with the reference table are not proper, save and restoration of the user range cannot be executed.

Before executing module control resumption, follow the flowchart in Section 4.6 and make offset/gain setting in the device test of GX Developer.

Perform mode switching by making the setting of Mode switching setting (Un\G158, Un\G159) and turning Operating condition setting request (Y9) from off to on.

Note that if module control is resumed without offset/gain setting being made, operation will be performed with the default values.

---



## (2) Dismounting of module

- (a) After choosing [Diagnostics] - [Online module change] in GX Developer to enter the "Online module change" mode, double-click the module to be changed online to display the "Online module change" dialog box.

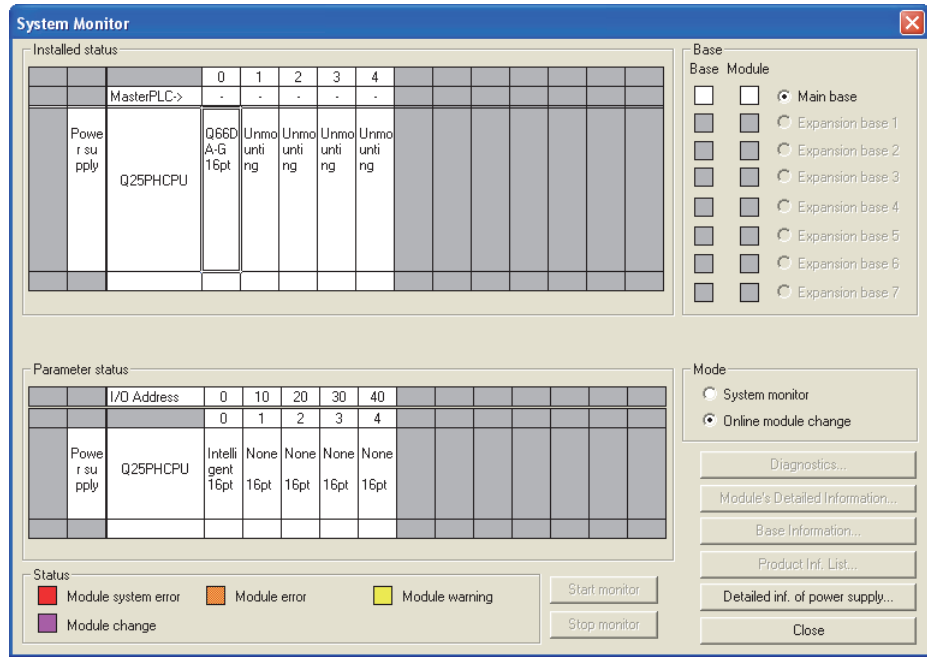

- (b) Click the "Execution" button to enable a module change.

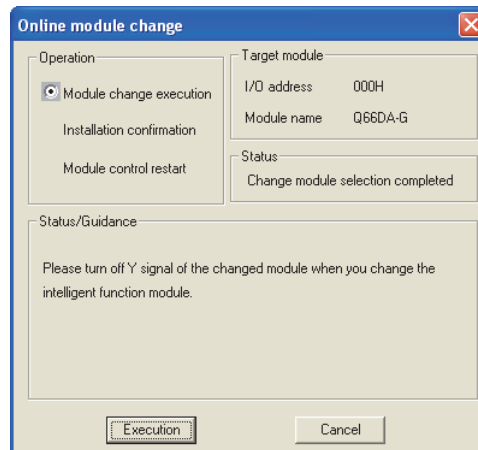

If the following error message appears, the user range data cannot be saved. Click the [OK] button, and perform the operation in This Section (2) (c) and later.



- (c) After confirming that the "RUN" LED of the module has turned off, remove the connector and dismount the module.

## ☒ Point

Always perform the dismounting procedure. If mounting confirmation is made without the module being dismounted, the module will not start properly and the "RUN" LED will not be lit.

### (3) Mounting of new module

- (a) Mount a new module to the same slot and install the connector.
- (b) After mounting the module, click the [Execution] button and make sure that the "RUN" LED is lit. Module READY (X0) remains off.

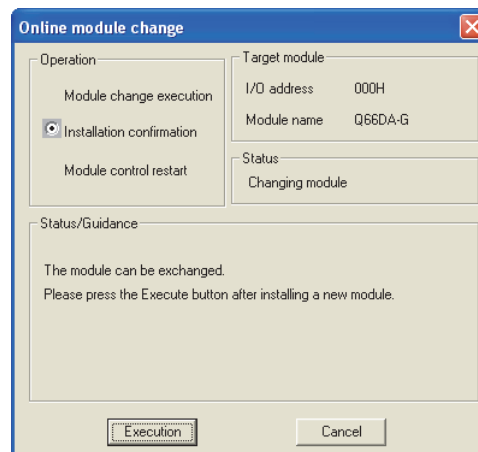

### (4) Operation check

- (a) To make an operation check, click the [Cancel] button to cancel control resumption.

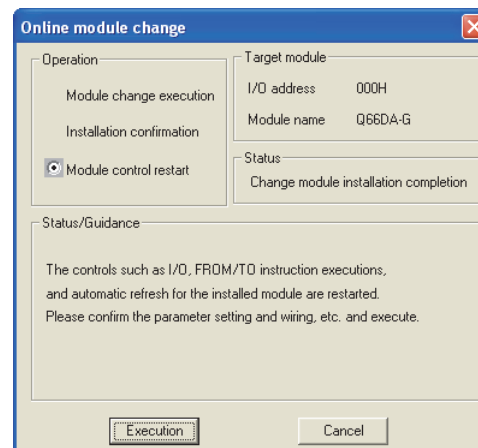

- (b) Click the [OK] button to leave the "Online module change" mode.

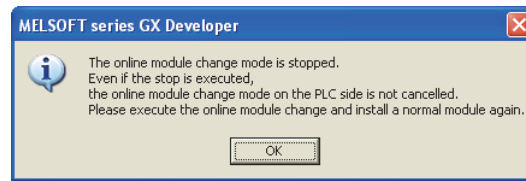

- (c) Click the [Close] button to close the System Monitor dialog box.

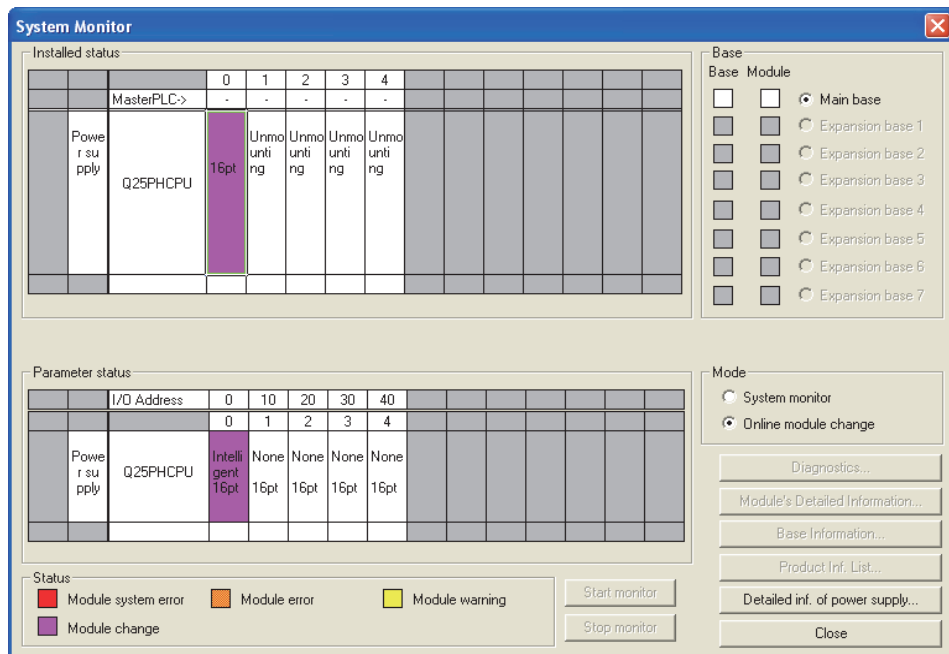

- (d) Choose [Online] - [Debug] - [Device test] on GX Developer and set the values prerecorded in Section (2) to the buffer memory.
- (e) Turn User range writing request (YA) from off to on to restore the user set values to the module.  
After confirming Offset/gain setting mode flag (XA) is on, turn off User range writing request (YA).
- (f) Enable the channels to be used in D/A conversion enable/disable setting (Un\G0). Set digital values to CH□ Digital value (Un\G1 to Un\G6) and turn Operating condition setting request (Y9) from off to on. Turn on Output enable/disable flag (Y1 to Y6) of the used channel to check whether proper conversion has been made or not.  
(Be careful since corresponding analog signals will be actually output.)

- (g) Since the new module is in a default status, it must be initialized by a sequence program after control resumption.

Before performing initialization, check whether the contents of the initialization program are correct or not.

### 1) Normal system configuration

The sequence program should perform initialization on the leading edge of Module READY (X9) of the Q66DA-G.

When control resumption is executed, Module READY (X0) turns on and initialization is performed. (If the sequence program performs initialization only for one scan after entering the RUN status, initialization is not performed.)

### 2) When used on remote I/O network

Insert a user device that will execute initialization at any timing (initialization request signal) into the sequence program. After control resumption, turn on the initialization request signal to perform initialization. (If the sequence program performs initialization only one scan after a data link start of the remote I/O network, initialization is not performed.)

## (5) Resumption of control

- (a) After choosing [Diagnostics] - [Online module change] in GX Developer to redisplay the "Online module change" dialog box, click the [Execution] button to resume control. Module READY (X0) will be turned on.

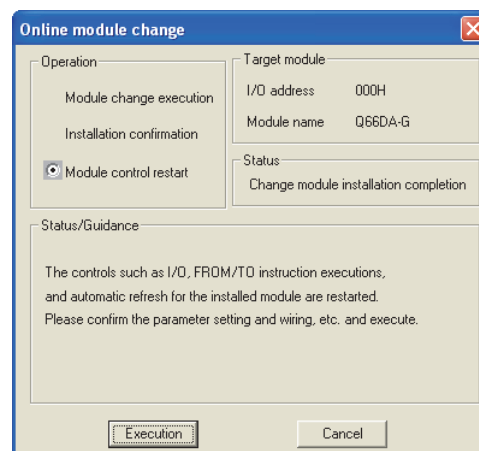

- (b) A message, "Online module change completed" appears.



## 7.4 Range Reference Table

The range reference tables are given below.

### (1) Reference table for CH□ Industrial shipment settings offset/gain value (Un\G202 to Un\G213)

The reference values change depending on the setting of Pass data classification setting (Un\G200).

Address (Decimal)						Description	Pass data classification setting		Reference value (Hexadecimal)
CH1	CH2	CH3	CH4	CH5	CH6				
202	204	206	208	210	212	Industrial shipment settings offset value	User range setting 1	0mA	Approx. 7FFF <sub>H</sub>
							User range setting 2	0V	Approx. 7FFF <sub>H</sub>
							User range setting 3	0V	Approx. 7FFF <sub>H</sub>
203	205	207	209	211	213	Industrial shipment settings gain value	User range setting 1	20mA	Approx. 24A0 <sub>H</sub>
							User range setting 2	10V	Approx. E4C8 <sub>H</sub>
							User range setting 3	5V	Approx. E4C8 <sub>H</sub>

### (2) Reference table for CH□ User range settings offset/gain value (Un\G214 to Un\G225)

Offset/gain value		Reference value
User range setting 1	0mA	Approx. 7FFF <sub>H</sub>
	4mA	Approx. 6DB9 <sub>H</sub>
	20mA	Approx. 24A0 <sub>H</sub>
User range setting 2	-10V	Approx. 1B36 <sub>H</sub>
	0V	Approx. 7FFF <sub>H</sub>
	10V	Approx. E4C8 <sub>H</sub>
User range setting 3	0V	Approx. 7FFF <sub>H</sub>
	1V	Approx. 9427 <sub>H</sub>
	5V	Approx. E4C8 <sub>H</sub>

[Example]

When using User range setting 3 in channel 1 and setting 1V to the offset value and 5V to the gain value, the following values are stored in the User range setting offset/gain value areas.

- CH1 User range settings offset value (Un\G214): Approx. 9427<sub>H</sub>
- CH1 User range settings gain value (Un\G215): Approx. E4C8<sub>H</sub>

## 7.5 Precautions for Online Module Change

---

The following are the precautions for online module change.

- (1) Always perform an online module change in the correct procedure. Failure to do so can cause a malfunction or failure.
- (2) If an online module change is made with the user range setting, the accuracy after that will fall to about less than three times of the accuracy before that.  
Re-set the offset/gain values as necessary.
- (3) Do not perform the following operations during online module change. If performed, the Q66DA-G may not operate properly.
  - (a) Powering off the programmable controller CPU
  - (b) Resetting the programmable controller CPU

## 8 TROUBLESHOOTING

This chapter explains the types of errors that may occur when the Q66DA-G is used, and how to troubleshoot such errors.

### 8.1 Error Code List

If an error occurs in the Q66DA-G while reading/writing data from/to the programmable controller CPU, the applicable error code is written to Error code (Un\G19).

Table8.1 Error code list (1/2)

Error code (decimal)	Error description	Processing
10□	The setting is outside the output range setting that can be made by the intelligent function module switch of the GX Developer. □ indicates the incorrectly specified channel number.	Reset to the correct parameter with GX Developer parameter setting. (Refer to Section 4.5.)
111	Hardware error of the module.	Turn the power on and off again. If the error occurs again, the module may be malfunctioning. Please consult your local Mitsubishi representative.
112	The value set to the intelligent function switch 5 is other than 0.	Re-set the correct parameter value in the parameter setting of GX Developer. (Refer to Section 4.5.)
120*1	An invalid value is set in the offset/gain setting. The number of the error channel cannot be identified.	Perform the offset/gain setting again for all of the channels that use the user range settings. If the error occurs again, the module may be malfunctioning. Please consult your local Mitsubishi representative.
12□*1	An invalid value is set in the offset/gain setting. □ indicates the channel number set incorrectly.	Perform the offset/gain setting again for the error channel. If the error occurs again, the module may be malfunctioning. Please consult your local Mitsubishi representative.
161*2	The G(P).OGSTOR instruction was executed in the offset/gain setting mode.	Do not execute the G(P).OGSTOR instruction in the offset/gain setting mode.
162*3	<ul style="list-style-type: none"> <li>The G(P).OGSTOR instruction was executed consecutively.</li> <li>At the time of offset/gain setting, a set value was written to the flash memory 26 or more times consecutively.</li> </ul>	<ul style="list-style-type: none"> <li>Execute the G(P).OGSTOR instruction only once for one module.</li> <li>At the time of offset/gain setting, write a set value only once at one time.</li> </ul>
163*3	The G(P).OGSTOR instruction was executed for the model that differs from the model for which the G(P).OGLOAD instruction had been executed.	Execute the G(P).OGLOAD and G(P).OGSTOR instructions for the same model.
164*3	The value set to the G(P).OGLOAD instruction, G(P).OGSTOR instruction or Save data classification setting (Un\G200) is outside the range.	Set the value within the range.

Table8.1 Error code list (2/2)

Error code (decimal)	Error description	Processing
40□*3	The offset value is equal to or larger than the gain value. □ indicates the channel number causing the error.	Reset so that the offset value is smaller than the gain value.
50□*3	More than one channel was set at the same time during offset/gain settings.	Set the correct value in Offset/ gain setting mode offset/ gain specification (Un\G22, Un\G23).
60□*3*4	The specified digital value is outside the range. □ indicates the channel number where the error occurred.	Set a value that is within the range.
61□*3	The warning output upper/lower limit value setting is outside the range -32000 to 32000. □ indicates the channel number incorrectly set.	Correct the contents of CH□ Warning output upper/lower limit value (Un\G86 to Un\G97) to within the range -32000 to 32000.
62□*3	The warning output lower limit value is equal to or greater than the warning output upper limit value. □ indicates the channel number incorrectly set.	Make setting so that the warning output upper limit value is greater than the warning output lower limit value.
70□*3	The analog adjustment output in the offset/gain setting mode is outside the specified value range.	Change the contents of Offset/gain adjustment value specification (Un\G24) so that it is within the range from -3000 to 3000.
71□*3	The value set for Offset/gain range setting is other than DH, EH, or FH.	Set either DH, EH, or FH for offset/gain range setting (Un\G25).
80□*3	The increase/decrease digital limit value setting is outside the range 0 to 64000. □ indicates the channel number incorrectly set.	Correct the contents of CH□ Increase/decrease digital limit value (Un\G70 to Un\G81) to within the range 0 to 64000.
90□*3	The scaling upper/lower limit value is set outside the range of -32000 to 32000. □ indicates the channel number set incorrectly.	Correct Scaling upper/lower limit value (Un\G54 to Un\G65) within the range of -32000 to 32000.
91□*3	The scaling lower limit value is equal to or greater than the scaling upper limit value. □ indicates the channel number set incorrectly.	Set CH□ Scaling upper/lower limit value (Un\G54 to Un\G65) so that the scaling upper limit value is greater than the scaling lower limit value.

## ☒ Point

- (1) When two or more errors occur, the latest error code is stored.
- (2) If Error code marked with \*1 occurs, D/A conversions for all the channels stop. Therefore, after correcting the offset/gain setting, make the initial setting again.
- (3) Error code 161 marked with \*2 is not stored in the Error code (Un\G19). It is written to the Completion status area, (S) + 1, of the G(P).OGSTOR instruction.
- (4) Error code marked with \*3 can be cleared by turning on Error clear request (YF).
- (5) If an error marked with \*4 occurs continuously, it is added to the error history of GX Developer for every conversion cycle.



## 8.2 Troubleshooting

### 8.2.1 When the "RUN" LED is flashing or turned off

#### (1) When flashing

Check item	Corrective action
Is the mode set to the offset/gain setting mode?	Reset switch 4 of the intelligent function module switch setting for GX Developer to the normal mode (Refer to Section 4.5).

#### (2) When off

Check item	Corrective action
Is power being supplied?	Confirm that the supply voltage for the power supply module is within the rated range.
Is the capacity of the power supply module adequate?	Calculate the current consumption of the CPU module, I/O module and intelligent function module mounted on the base unit to see if the power supply capacity is adequate.
Has a watchdog timer error occurred?	Reset the programmable controller CPU and verify that it is lit. If the RUN LED does not light even after doing this, the module may be malfunctioning. Please consult your local Mitsubishi representative.
Is the module correctly mounted on the base unit?	Check the mounting condition of the module.
Is a module change enabled during an online module change?	Refer to Chapter 7 and take corrective action.

### 8.2.2 When the "ERR." LED is on or flashing

#### (1) When turning on

Check item	Corrective action
Is an error being generated?	Confirm the error code and take corrective action described in Section 8.1.

#### (2) When flashing

Check item	Corrective action
Is intelligent function module setting switch 5 set to "other than 0"?	Using GX Developer parameter setting, set intelligent function module setting switch 5 to "0" (Refer to Section 4.5).

### 8.2.3 When the "ALM" LED is turned on

Check item	Corrective action
Has the warning output occurred?	Check Warning output flag (Un\G48).

1 OVERVIEW  
2 SYSTEM CONFIGURATION  
3 SPECIFICATIONS  
4 SETUP AND PROCEDURES BEFORE OPERATION  
5 UTILITY PACKAGE (GX CONFIGURATOR-DA)  
6 PROGRAMMING  
7 ONLINE MODULE CHANGE  
8 TROUBLESHOOTING

## 8.2.4 When an analog output value is not output

Check item	Action to be taken
Is 24VDC being supplied from the external power supply? (If not, "External power supply (X7)" is off.)	Verify that 24VDC voltage is being supplied to the external power supply terminals (between terminals No. A19 and A20 or B19 and B20).
Is there any fault with the analog signal lines such as broken or disconnected line?	Check for any abnormality on the signal lines by a visual check and a continuity check.
Is the CPU module in the STOP status?	Set the CPU module to the RUN status.
Are the offset/gain settings correct?	Verify that the offset/gain settings are correct (Refer to sections 4.6 and 5.6.2). If the user range setting is being used, switch to a different default output range and check if D/A conversion is correctly performed. If it is correctly performed, redo the offset/gain settings.
Is the output setting range correct?	Verify Setting range (Un\G20, Un\G21) in GX Developer monitor. If the output range setting is incorrect, redo GX Developer intelligent function module switch settings (Refer to Section 4.5).
Is the resolution mode setting correct?	Check the on/off status of High resolution mode status flag (X8) in GX Developer system monitor. If the resolution mode setting is incorrect, redo the GX Developer intelligent function module switch setting. (Refer to Section 4.5).
Is the D/A conversion enable/disable setting for the channel to be output set to Disable?	Check D/A conversion enable/disable setting (Un\G0) in GX Developer monitor and set it to Enable using the sequence program or utility package (Refer to Section 3.4).
Is the D/A output enable/disable setting for the channel to be output set to Disable?	Verify on/off for CH□ Output enable/disable flag (Y1 to Y6) in GX Developer monitor. If Output enable/disable flag are off, review the initial setting for the sequence program or utility package (Refer to Section 3.3).
Is the digital value being written to the channel to be output?	Verify CH□ Digital value (Un\G1 to Un\G6) in GX Developer monitor (Refer to Section 3.4).
Has Operating condition setting request (Y9) been executed?	Set Operating condition setting request (Y9) from on to off from GX Developer and check to Refer to if the analog output is normal. If normal analog output is obtained, review the initial setting for the sequence program or utility package (Refer to Section 3.3).

### ☒ Point

If the analog output value is not output after the proper corrective action is taken in accordance with the above check item, the possible cause is a module failure. Please consult your local Mitsubishi representative.

## 8.2.5 When the analog value is not within the reference accuracy of the theoretical value

Check item	Action to be taken
When using voltage output, is a small load resistance of the connected external device and a long wiring distance observed?	If observed, because a voltage drop due to the wiring impedance and load current is large and the voltage applied to the external device is low, the factory default range setting may not satisfy the reference accuracy. In this case, use User range setting and adjust the offset and gain values after wiring.

## 8.2.6 When analog output value is not "HOLD"

Check item	Action to be taken
Is the HOLD/CLEAR setting correct?	Check the Switch 3 setting of the intelligent function module switch setting on GX Developer.
Is the Q66DA-G used on a MELSECNET/H remote I/O station?	Take action, referring to POINT in Section 3.2.1.

## 8.2.7 When External power supply READY (X7) does not turn on

Check item	Action to be taken
Is the external power supply 24VDC supplied? (1) Is the external power supply correctly wired? (2) Is the external power supply 24VDC supplied within the specified range?	(1) Wire the external power supply by referring to the "External wiring".(Refer to Section 4.4.2) (2) Supply 24VDC within the range of the performance specifications. (Refer to Section 3.1.1)
The case other than the above	The possible cause is a failure of the Q66DA-G. Please consult your local Mitsubishi representative.

## 8.2.8 Checking the Q66DA-G status using GX Developer system monitor

When the Q66DA-G detail information is selected in GX Developer system monitor, function version, error code, LED on status and status of the intelligent function module switch setting can be checked.

### (1) Operating the GX Developer

[Diagnostics] → [System monitor] → "Select Q66DA-G" →

Module's Detailed Information

### (2) Module Detailed Information

#### (a) Checking the function version

The function version of the Q66DA-G is displayed in the product information field.

#### (b) Checking Error code

Error code stored in buffer memory address 19 (Un\G19) of the Q66DA-G is displayed in the Present Error field.

(When the button **Error History** is pressed, the contents displayed in the Present Error field are displayed in the No.1 field.)

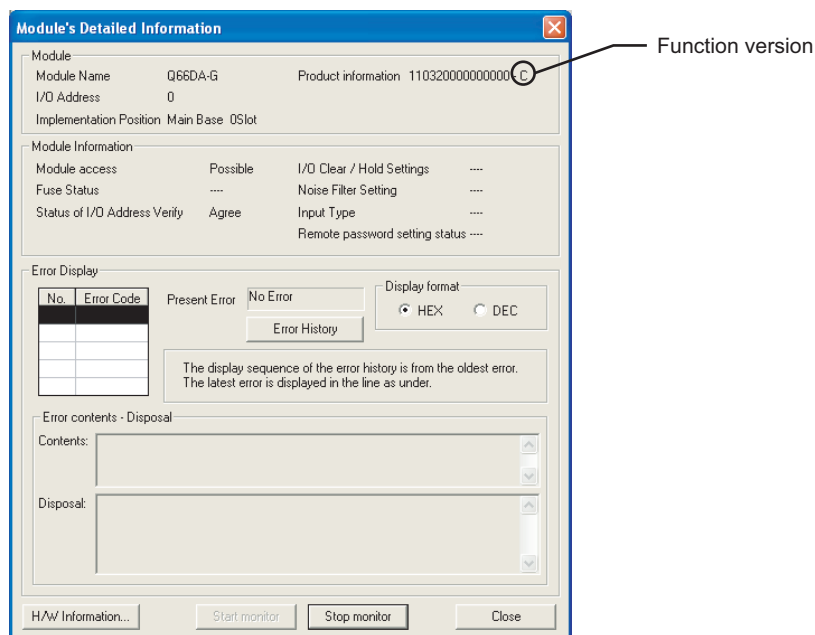

### (3) H/W information

#### (a) H/W LED information

The LED status is displayed.

No.	LED name	Status
1)	RUN LED	0000H : Indicates that LED is unlit.
2)	ERR. LED	0001H : Indicates that LED is lit.
3)	ALM LED	0000H and 0001H are displayed alternately: Indicates that LED is flashing.

#### (b) H/W SW information

The status of the intelligent function module switch setting is displayed.

Item	Switch setting for intelligent function module
RANGE1	Switch 1
RANGE2	Switch 2
HOLD/CLEAR	Switch 3
MODE	Switch 4
-	Switch 5

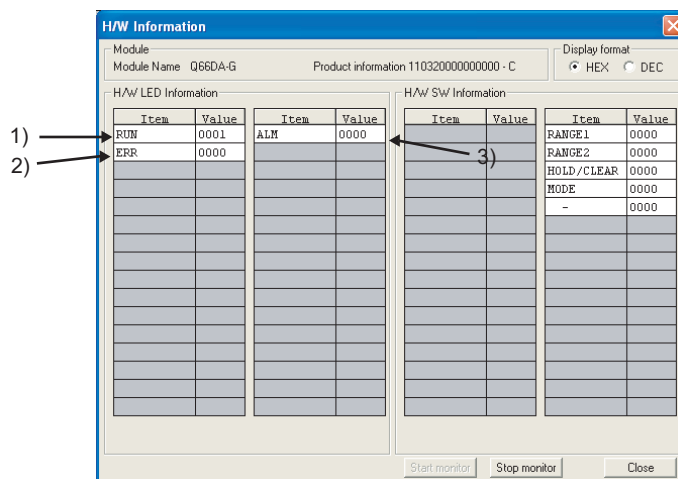

(In the case of GX Developer Version 8)

## APPENDICES

## Appendix 1 Dedicated Instruction List and Available Devices

### (1) Dedicated instruction list

The following table lists the dedicated instructions that can be used with the Q66DA-G.

Instruction	Description	Reference section
G(P).OFFGAN	Switches to the offset/gain setting mode. Switches to the normal mode.	Appendix 1.1
G(P).OGLOAD	Reads the offset/gain values of the user range setting to the CPU.	Appendix 1.2
G(P).OGSTOR	Restores the offset/gain values of the user range setting stored in the CPU to the Q66DA-G.	Appendix 1.3

### ☒ Point

When the module is mounted to a MELSECNET/H remote station, the dedicated instructions cannot be used.

### (2) Available devices

The following devices are available for the dedicated instructions:

Internal devices		File register	Constant <sup>*2</sup>
Bit <sup>*1</sup>	Word		
X, Y, M, L, F, V, B	T, ST, C, D, W	R, ZR	K, H

\*1 Word device bit designation can be used as bit data.

Word device bit designation is done by designating Word device . Bit No. .  
(Designation of bit numbers is done in hexadecimal.)

For example, bit 10 of D0 is designated as D0.A.

However, there can be no bit designation for timers (T), retentive timers (ST) and counters (C).

\*2 Available devices are given in each of the Constant field.

Appendix 1.1 G(P).OFFGAN

Switches the mode of the Q66DA-G. (Normal mode to offset/gain setting mode, offset/gain setting mode to normal mode)

Setting data	Usable devices									
	Internal device (System, user)		File register	Link direct device J□□		Intelligent function module device U□\G□	Index register Z□	Constant		Others
	Bit	Word		Bit	Word			K, H	\$	
(S)	—	○			—		—	—	—	

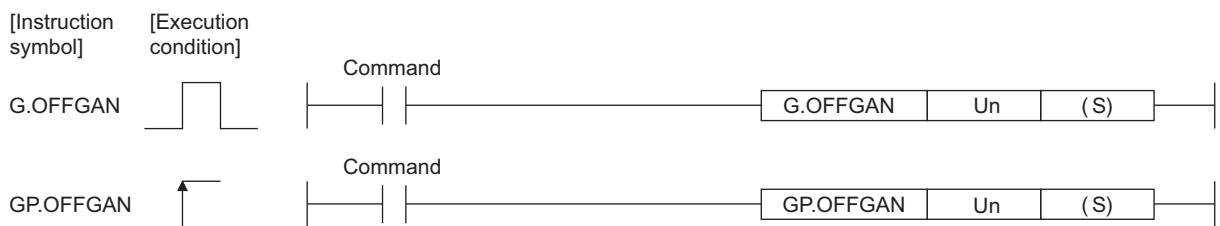

Setting data

Setting data	Description	Setting range	Data type
Un	Start I/O number of the module	0 to FEH	Binary 16 bits
(S)	Mode switching 0: Switching to normal mode 1: Switching to offset/gain setting mode The setting of any other value results in "switching to offset/gain setting mode".	0, 1	Binary 16 bits

(1) Function

Switches the mode of the Q66DA-G.

- Normal mode to offset/gain setting mode (Offset/gain setting mode flag (XA) turns on.)
- Offset/gain setting mode to normal mode (Offset/gain setting mode flag (XA) turns off.)

☒ Point

- (1) When the offset/gain setting mode is switched to the normal mode, Module READY (X0) turns from off to on.  
Note that initial setting processing will be executed if there is a sequence program that makes initial setting when Module READY (X0) turns on.
- (2) D/A conversion is discontinued if the mode is switched (from the normal mode to the offset/gain setting mode or from the offset/gain setting mode to the normal mode).  
To resume D/A conversion, switch to the normal mode and then turn on Operating condition setting request (Y9).

**(2) Operation error**

No errors.

**(3) Program example**

The following program is designed to switch the Q66DA-G mounted in the position of I/O number X/Y0 to X/YF to the offset/gain setting mode when M10 is turned on, and to return it to the normal mode when M10 is turned off.

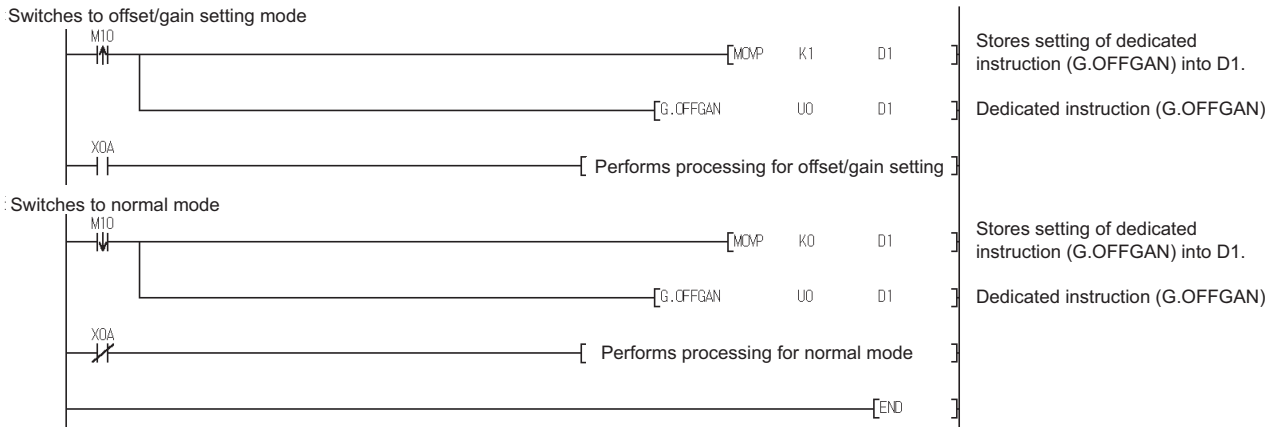



Appendix 1.2 G(P).OGLOAD

Reads the offset/gain values of the user range setting of the Q66DA-G to the CPU.

Setting data	Usable devices									
	Internal device (System, user)		File register	Link direct device J□\□		Intelligent function module device U□\G□	Index register Z□	Constant		Others
	Bit	Word		Bit	Word			K, H	\$	
(S)	—	○			—			—	—	—
(D)		○			—			—	—	—

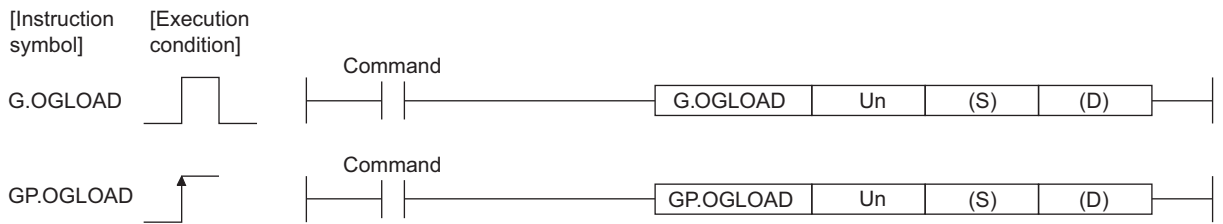

Setting data

Setting data	Description	Setting range	Data type
Un	Start I/O number of the module	0 to FEH	Binary 16 bits
(S)	Start number of the device in which control data is stored.	Within the range of the specified device	Device name
(D)	Device that is turned on 1 scan on completion of dedicated instruction processing. (D) + 1 also turns on at an abnormal completion.	Within the range of the specified device	Bit

Control data (1/2) \*1

Device	Item	Setting data	Setting range	Set by
(S)	System area	-	-	-
(S) + 1	Completion status	Stores the status when the instruction is complete. 0 : Normal completion Other than 0: Abnormal completion	-	System
(S) + 2	Pass data classification setting	Specify the user range setting where offset/gain values will be read. 00H: Use range setting 1 specified 01H: Use range setting 2 specified 10H: Use range setting 3 specified  b15 to b0 □ to □ □ □ □ □ □ □ □ □ □ □ □ □ □ □ □ 0: Fixed CH6 CH5 CH4 CH3 CH2 CH1	0000H to 0AAA H	User
(S) + 3	System area	-	-	-
(S) + 4	CH1 Industrial shipment settings offset value	-	-	System
(S) + 5	CH1 Industrial shipment settings gain value	-	-	System
(S) + 6	CH2 Industrial shipment settings offset value	-	-	System
(S) + 7	CH2 Industrial shipment settings gain value	-	-	System

## Control data (2/2) \*1

Device	Item	Set data	Setting range	Set by
(S) + 7	CH2 Industrial shipment settings gain value	-	-	System
(S) + 8	CH3 Industrial shipment settings offset value	-	-	System
(S) + 9	CH3 Industrial shipment settings gain value	-	-	System
(S) + 10	CH4 Industrial shipment settings offset value	-	-	System
(S) + 11	CH4 Industrial shipment settings gain value	-	-	System
(S) + 12	CH5 Industrial shipment settings offset value	-	-	System
(S) + 13	CH5 Industrial shipment settings gain value	-	-	System
(S) + 14	CH6 Industrial shipment settings offset value	-	-	System
(S) + 15	CH6 Industrial shipment settings gain value	-	-	System
(S) + 16	CH1 User range settings offset value	-	-	System
(S) + 17	CH1 User range settings gain value	-	-	System
(S) + 18	CH2 User range settings offset value	-	-	System
(S) + 19	CH2 User range settings gain value	-	-	System
(S) + 20	CH3 User range settings offset value	-	-	System
(S) + 21	CH3 User range settings gain value	-	-	System
(S) + 22	CH4 User range settings offset value	-	-	System
(S) + 23	CH4 User range settings gain value	-	-	System
(S) + 24	CH5 User range settings offset value	-	-	System
(S) + 25	CH5 User range settings gain value	-	-	System
(S) + 26	CH6 User range settings offset value	-	-	System
(S) + 27	CH6 User range settings gain value	-	-	System
(S) + 28 to (S) + 35	System area	-	-	System

\*1 Set only Pass data classification setting (S)+2. If data is written to the area set by the system, the off-set/gain values will not be read properly.

\*2 The set value of Pass data classification setting, (S) + 2, varies depending on the module. Attention must be paid.

\*3 An area of 36 words is required for (S).

**(1) Functions**

- (a) Reads the offset/gain values of the user range setting of the Q66DA-G to the CPU.
- (b) There are two types of interlock signals for the G(P).OGLOAD instruction: the completion device (D) and the status display device at completion (D) + 1.

**1) Completion device**

Turns on in the END processing of the scan where the G(P).OGLOAD instruction is completed, and turns off in the next END processing.

**2) Status display device at completion**

Turns on and off depending on the completion status of the G(P).OGLOAD instruction.

Normal completion : Stays off and does not change.

Abnormal completion : Turns on in the END processing of the scan where the G(P).OGLOAD instruction is completed, and turns off in the next END processing.

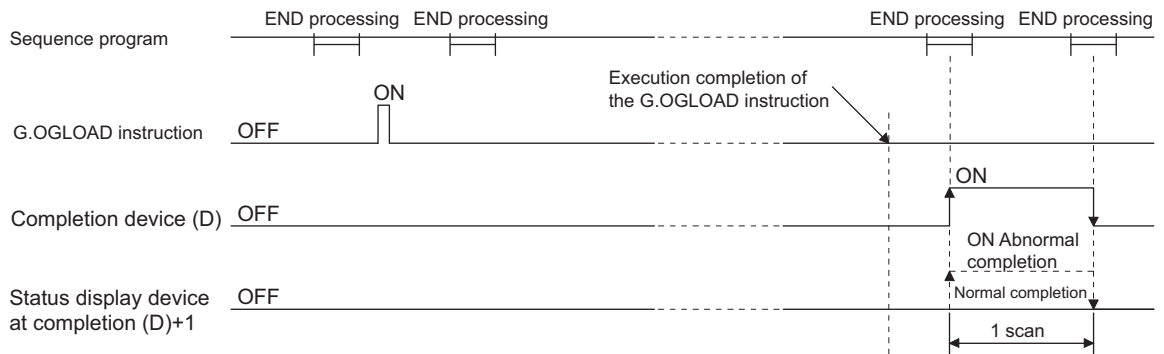

**(2) Operation error**

In the following case, an error occurs and the corresponding error code is stored into the completion status area (S)+1.

Error code	Case resulting in operation error
164	The value set to Pass data classification setting (S)+2 is outside the range.

**(3) Program example**

The following program is designed to read the offset/gain values of the Q66DA-G mounted in the position of I/O number X/Y0 to X/YF when M11 is turned on.

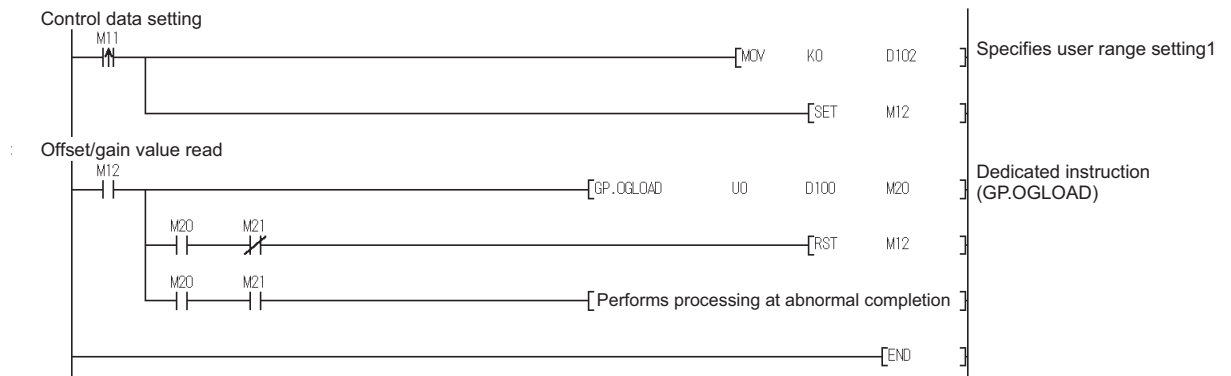

Appendix 1.3 G(P).OGSTOR

Restores the offset/gain values of the user range setting stored in the CPU to the Q66DA-G.

Setting data	Usable devices									
	Internal device (System, user)		File register	Link direct device J□\□		Intelligent function module device U□\G□	Index register Z□	Constant		Others
	Bit	Word		Bit	Word			K, H	\$	
(S)	—	○						—	—	—
(D)		○						—	—	—

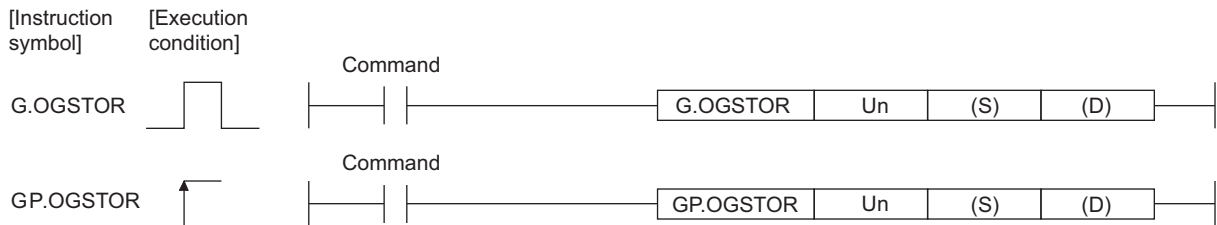

Setting data

Setting data	Description	Setting range	Data type
Un	Start I/O number of the module	0 to FEH	Binary 16 bits
(S)*1	Start number of the device in which control data is stored.	Within the range of the specified device	Device name
(D)	Device that is turned on 1 scan on completion of dedicated instruction processing. (D) + 1 also turns on at an abnormal completion.	Within the range of the specified device	Bit

\*1 When executing the G(P).OGLOAD instruction, specify the device designated in (S). Do not change the data read with the G(P).OGLOAD instruction. If it is changed, normal operation cannot be guaranteed.

## Control data \*1

Device	Item	Setting data	Setting range	Set by
(S)	System area	-	-	-
(S) + 1	Completion status	Stores the status when the instruction is complete. 0 : Normal completion Other than 0: Abnormal completion (error code)	-	System
(S) + 2	Pass data classification setting	The value set to pass data classification setting (S)+2 using the G(P).OGLOAD instruction is stored. 00H: Use range setting 1 specified 01H: Use range setting 2 specified 10H: Use range setting 3 specified  <div style="display: flex; justify-content: space-around; font-size: small;"> <span>b15</span><span>b12</span><span>b11</span><span>b10</span><span>b9</span><span>b8</span><span>b7</span><span>b6</span><span>b5</span><span>b4</span><span>b3</span><span>b2</span><span>b1</span><span>b0</span> </div> <div style="display: flex; justify-content: space-around; font-size: x-small; margin-top: 5px;"> <span>□ to □</span><span>□ □</span><span>□ □</span><span>□ □</span><span>□ □</span><span>□ □</span><span>□ □</span><span>□ □</span><span>□ □</span><span>□ □</span><span>□ □</span><span>□ □</span><span>□ □</span><span>□ □</span> </div> <div style="display: flex; justify-content: space-around; font-size: x-small; margin-top: 5px;"> <span>0: Fixed</span><span>CH6</span><span>CH5</span><span>CH4</span><span>CH3</span><span>CH2</span><span>CH1</span> </div>	-	User
(S) + 3	System area	-	-	-
(S) + 4	CH1 Industrial shipment settings offset value	-	-	System
(S) + 5	CH1 Industrial shipment settings gain value	-	-	System
(S) + 6	CH2 Industrial shipment settings offset value	-	-	System
(S) + 7	CH2 Industrial shipment settings gain value	-	-	System
(S) + 8	CH3 Industrial shipment settings offset value	-	-	System
(S) + 9	CH3 Industrial shipment settings gain value	-	-	System
(S) + 10	CH4 Industrial shipment settings offset value	-	-	System
(S) + 11	CH4 Industrial shipment settings gain value	-	-	System
(S) + 12	CH5 Industrial shipment settings offset value	-	-	System
(S) + 13	CH5 Industrial shipment settings gain value	-	-	System
(S) + 14	CH6 Industrial shipment settings offset value	-	-	System
(S) + 15	CH6 Industrial shipment settings gain value	-	-	System
(S) + 16	CH1 User range settings offset value	-	-	System
(S) + 17	CH1 User range settings gain value	-	-	System
(S) + 18	CH2 User range settings offset value	-	-	System
(S) + 19	CH2 User range settings gain value	-	-	System
(S) + 20	CH3 User range settings offset value	-	-	System
(S) + 21	CH3 User range settings gain value	-	-	System
(S) + 22	CH4 User range settings offset value	-	-	System
(S) + 23	CH4 User range settings gain value	-	-	System
(S) + 24	CH5 User range settings offset value	-	-	System
(S) + 25	CH5 User range settings gain value	-	-	System
(S) + 26	CH6 User range settings offset value	-	-	System
(S) + 27	CH6 User range settings gain value	-	-	System
(S) + 28 to (S) + 35	System area	-	-	System

\*1 When executing the G.OGLOAD instruction, specify the device designated in (S).  
Do not change the data read with the G.OGLOAD instruction.  
If it is changed, normal operation cannot be guaranteed.

\*2 The set value of the Pass data classification setting, (S) + 2, varies depending on the module.  
Attention must be paid.

\*3 An area of 36 words is required for (S).

**(1) Functions**

- (a) Restores the offset/gain values of the user range setting stored in the CPU to the Q66DA-G.
- (b) There are two types of interlock signals for the G(P).OGSTOR instruction: the completion device (D) and the status display device at completion (D) + 1.

**1) Completion device**

Turns on in the END processing of the scan where the G(P).OGSTOR instruction is completed, and turns off in the next END processing.

**2) Status display device at completion**

Turns on and off depending on the completion status of the G(P).OGSTOR instruction.

Normal completion : Stays off and does not change.

Abnormal completion : Turns on in the END processing of the scan where the G(P).OGSTOR instruction is completed, and turns off in the next END processing.

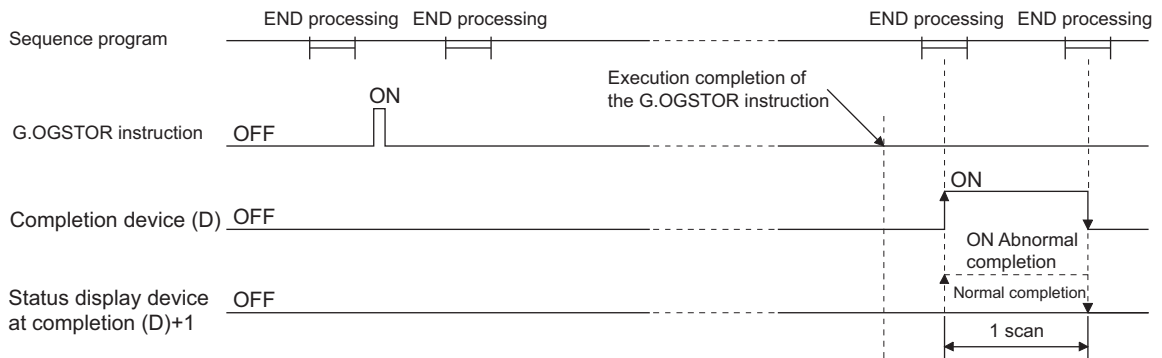

- (c) When the offset/gain values are restored, the reference accuracy falls to about less than three times of the accuracy before that.

**(2) Operation error**

In any of the following cases, an error occurs and the corresponding error code is stored into the completion status area (S)+1.

Error code	Case resulting in operation error
161	The G(P).OGSTOR instruction was executed in the offset/gain setting mode.
162	The G(P).OGSTOR instruction was executed consecutively.
163	The G(P).OGSTOR instruction was executed for the model that differs from the model for which the G(P).OGLOAD instruction had been executed.
164	The value set to the pass data classification setting (S)+2 is outside the range.

**(3) Program example**

The following program is designed to read the offset/gain values of the Q66DA-G mounted in the position of I/O number X/Y0 to X/YF when M11 is turned on.

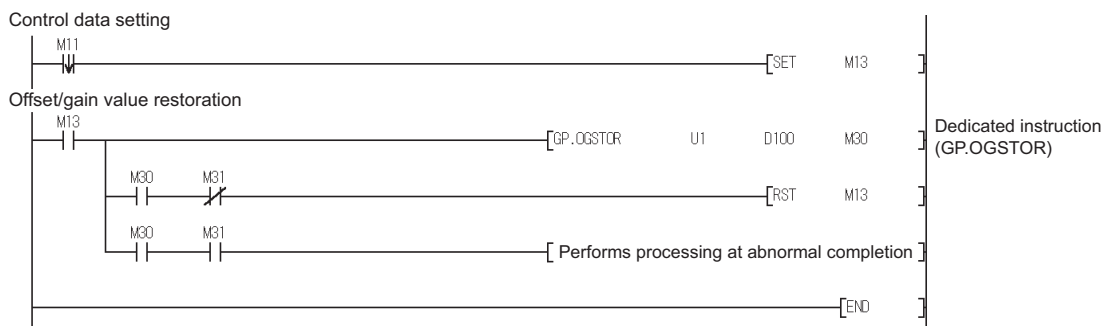

## Appendix 2 Functions Added or Changed Due to Version Upgrade

The Q66DA-G has been upgraded with new functions and specifications. The functions available for the Q66DA-G vary depending on the first five digits of the product number.

**TableApp.1 Functions Added or Changed Due to Version Upgrade**

Added function	Description	First 5 digits of product number	Reference section
Analog output range extended mode	By selecting either of the following output ranges in the intelligent function module switch setting, the analog output ranges can be extended. <ul style="list-style-type: none"> <li>• 4 to 20mA (Extended mode)</li> <li>• 1 to 5V (Extended mode)</li> </ul> Some incompatible version products do not support the analog output range extended mode.	11032 or later	Section3.1.1 Section(4.5)

Appendix 3 External Dimensions

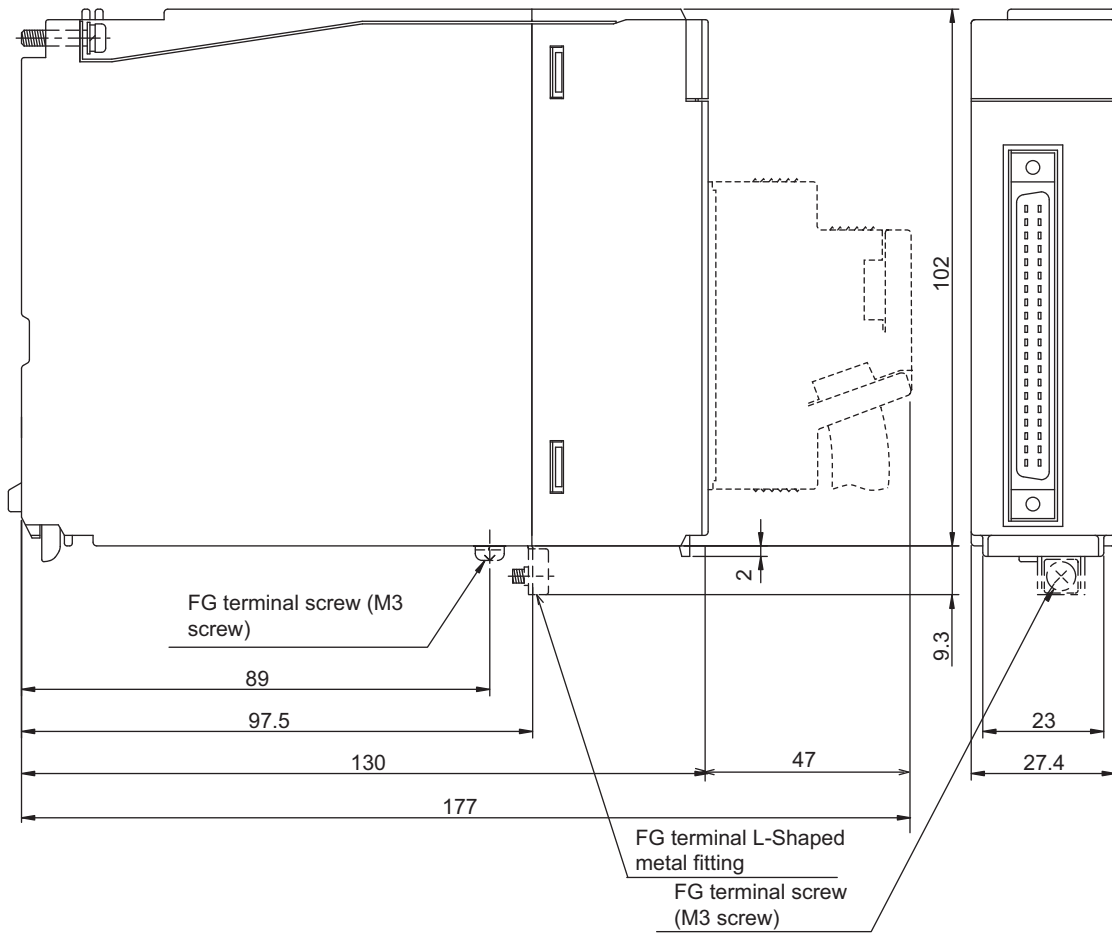

(Unit: mm (inch))



# INDEX

## [A]

Absolute maximum output .....	3-1
Accuracy .....	3-1,3-7
ALM LED .....	4-4
Analog output .....	3-1
Analog output HOLD/CLEAR function .....	3-8
Analog output test during programmable controller CPU STOP .....	3-8

## [B]

Buffer memory .....	3-25
---------------------	------

## [C]

CH Digital value (Un\G1 to Un\G6).....	3-28
CH Set value check code (Un\G11 to Un\G16) ...	3-29
Channel change completed flag .....	3-19,3-22
Channel change request .....	3-23
Conversion speed.....	3-1
Current output characteristic .....	3-5

## [D]

D/A conversion enable/disable function .....	3-8
D/A conversion enable/disable setting (Un\G0) .....	3-28
D/A output enable/disable function .....	3-8
Dedicated Instruction.....	App-1
Digital input.....	3-1

## [E]

ERR. LED .....	4-4
Error clear request.....	3-19
Error code (Un\G19).....	3-29
Error code list .....	8-1
Error flag.....	3-19
External Dimensions.....	App-11
External supply power .....	3-2

## [F]

Function Version.....	2-4
-----------------------	-----

## [G]

G(P).OFFGAN .....	App-2
G(P).OGLOAD.....	App-4
G(P).OGSTOR .....	App-7
GX Configurator-DA .....	2-2
GX Developer .....	A-13,2-2

## [H]

Handling Precautions .....	4-1
----------------------------	-----

## [I]

Installing .....	5-2
Internal current consumption .....	3-2

## [L]

List of I/O signals .....	3-19
---------------------------	------

## [M]

Maximum resolution.....	3-1
Mode switching setting (Un\G158, Un\G159) .....	3-27
Module ready .....	3-19
Monitor/Test.....	5-1
Multiple programmable controller system .....	2-1

## [O]

OFFGAN.....	App-1
Offset value.....	3-2
Offset/gain adjustment value specification (Un\G24) .....	3-25
Offset/gain setting mode.....	3-25
Offset/gain setting mode flag .....	3-19
OGSTOR .....	App-7
Online module change.....	7-1
Operating condition setting completed flag.....	3-21
Operating condition setting request .....	3-23
Operating environment .....	5-4

## [P]

Part Identification Nomenclature.....	4-4
Part identification nomenclature .....	4-4
Pass data classification setting.....	3-35
Pass data.....	5-27
Programming .....	6-1

## [Q]

QCPU (Q mode) .....	A-13
---------------------	------

## [R]

Rate control enable/disable setting (Un\G46).....	3-25
Rate control function.....	3-8
RUN LED .....	4-4

## [S]

Set value change completed flag.....	3-19
Set value change request .....	3-23
Setting range .....	3-25
Setup and Procedures before Operation .....	4-1

## [T]

Troubleshooting .....	8-1
-----------------------	-----

## [U]

Uninstalling .....	5-2
User range writing request.....	3-19

## [V]

Voltage output characteristic .....	3-3
-------------------------------------	-----

**[W]**

Warning output clear request .....	3-19
Warning output flag .....	3-25
Warning output function.....	3-8
Warning output signal .....	3-19
Weight .....	3-2

# **WARRANTY**

Please confirm the following product warranty details before using this product.

## **1. Gratis Warranty Term and Gratis Warranty Range**

If any faults or defects (hereinafter "Failure") found to be the responsibility of Mitsubishi occurs during use of the product within the gratis warranty term, the product shall be repaired at no cost via the sales representative or Mitsubishi Service Company.

However, if repairs are required onsite at domestic or overseas location, expenses to send an engineer will be solely at the customer's discretion. Mitsubishi shall not be held responsible for any re-commissioning, maintenance, or testing on-site that involves replacement of the failed module.

[Gratis Warranty Term]

The gratis warranty term of the product shall be for one year after the date of purchase or delivery to a designated place. Note that after manufacture and shipment from Mitsubishi, the maximum distribution period shall be six (6) months, and the longest gratis warranty term after manufacturing shall be eighteen (18) months. The gratis warranty term of repair parts shall not exceed the gratis warranty term before repairs.

[Gratis Warranty Range]

- (1) The range shall be limited to normal use within the usage state, usage methods and usage environment, etc., which follow the conditions and precautions, etc., given in the instruction manual, user's manual and caution labels on the product.
- (2) Even within the gratis warranty term, repairs shall be charged for in the following cases.
  1. Failure occurring from inappropriate storage or handling, carelessness or negligence by the user. Failure caused by the user's hardware or software design.
  2. Failure caused by unapproved modifications, etc., to the product by the user.
  3. When the Mitsubishi product is assembled into a user's device, Failure that could have been avoided if functions or structures, judged as necessary in the legal safety measures the user's device is subject to or as necessary by industry standards, had been provided.
  4. Failure that could have been avoided if consumable parts (battery, backlight, fuse, etc.) designated in the instruction manual had been correctly serviced or replaced.
  5. Failure caused by external irresistible forces such as fires or abnormal voltages, and Failure caused by force majeure such as earthquakes, lightning, wind and water damage.
  6. Failure caused by reasons unpredictable by scientific technology standards at time of shipment from Mitsubishi.
  7. Any other failure found not to be the responsibility of Mitsubishi or that admitted not to be so by the user.

## **2. Onerous repair term after discontinuation of production**

- (1) Mitsubishi shall accept onerous product repairs for seven (7) years after production of the product is discontinued. Discontinuation of production shall be notified with Mitsubishi Technical Bulletins, etc.
- (2) Product supply (including repair parts) is not available after production is discontinued.

## **3. Overseas service**

Overseas, repairs shall be accepted by Mitsubishi's local overseas FA Center. Note that the repair conditions at each FA Center may differ.

## **4. Exclusion of loss in opportunity and secondary loss from warranty liability**

Regardless of the gratis warranty term, Mitsubishi shall not be liable for compensation to:

- (1) Damages caused by any cause found not to be the responsibility of Mitsubishi.
- (2) Loss in opportunity, lost profits incurred to the user by Failures of Mitsubishi products.
- (3) Special damages and secondary damages whether foreseeable or not, compensation for accidents, and compensation for damages to products other than Mitsubishi products.
- (4) Replacement by the user, maintenance of on-site equipment, start-up test run and other tasks.

## **5. Changes in product specifications**

The specifications given in the catalogs, manuals or technical documents are subject to change without prior notice.

Microsoft and Windows are either registered trademarks or trademarks of Microsoft Corporation in the United States and/or other countries.

Celeron, Intel, and Pentium are either registered trademarks or trademarks of Intel Corporation in the United States and/or other countries.

Ethernet is a registered trademark of Fuji Xerox Co., Ltd. in Japan.

The company names, system names and product names mentioned in this manual are either registered trademarks or trademarks of their respective companies.

In some cases, trademark symbols such as '™' or '®' are not specified in this manual.

SPREAD

Copyright (c) 2006 FarPoint Technologies, Inc.



SH(NA)-080648ENG-I(1707)MEE

MODEL: Q-D/A-G-U-SY-E

MODEL CODE: 13JR97

## **MITSUBISHI ELECTRIC CORPORATION**

HEAD OFFICE : TOKYO BUILDING, 2-7-3 MARUNOUCHI, CHIYODA-KU, TOKYO 100-8310, JAPAN  
NAGOYA WORKS : 1-14, YADA-MINAMI 5-CHOME, HIGASHI-KU, NAGOYA, JAPAN

When exported from Japan, this manual does not require application to the Ministry of Economy, Trade and Industry for service transaction permission.

Specifications subject to change without notice.